

# RESPECTER IMPERATIVEMENT L'ORDRE DE MONTAGE.

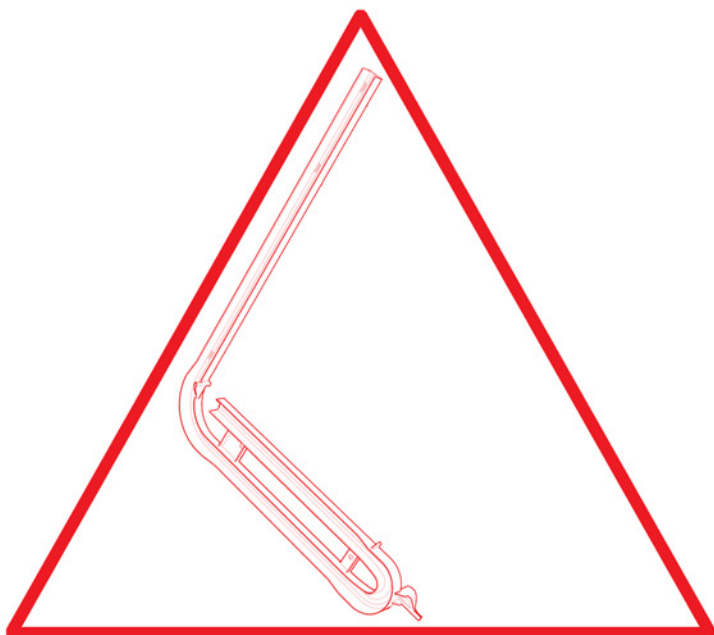

**Etape 12)**

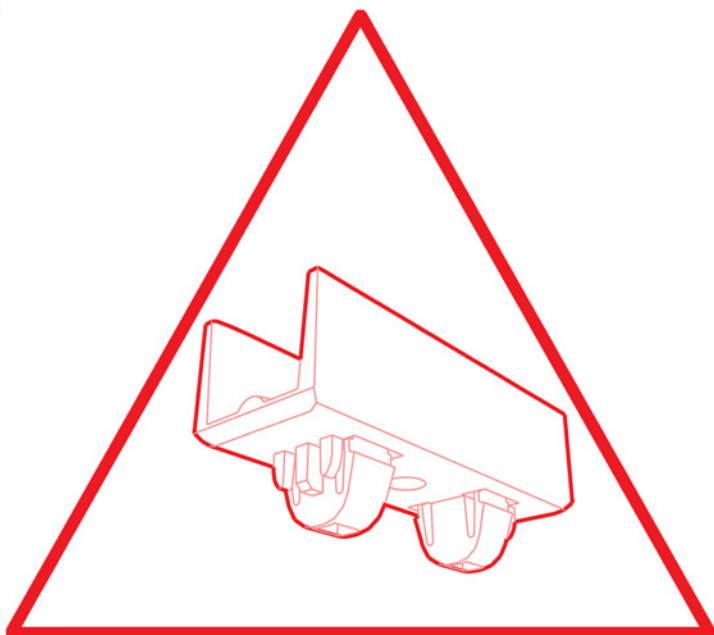
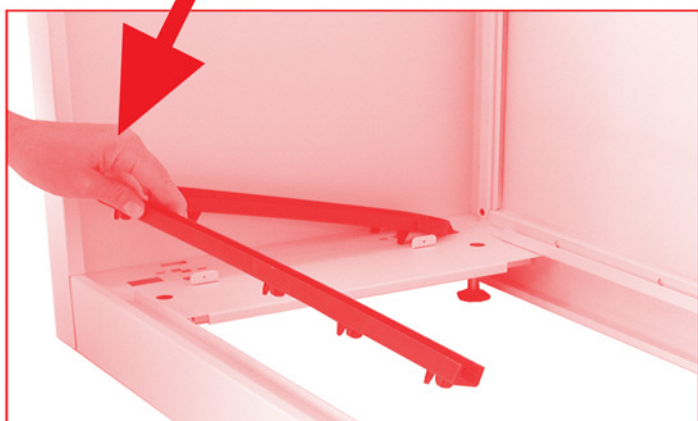

**Etape 23)**



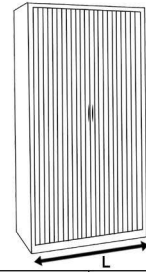
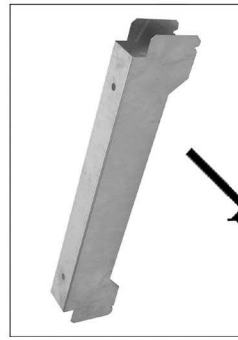
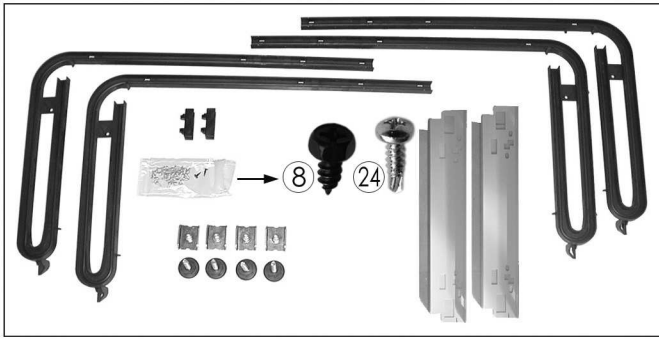

1 x	L = 1200 mm
1 x	L = 1000 mm
0	L = 800 mm

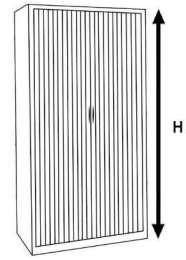

5 x	H = 2200 mm
4 x	H = 1980 mm
3 x	H = 1608 mm
2 x	H = 1000 mm
1 x	H = 695 mm

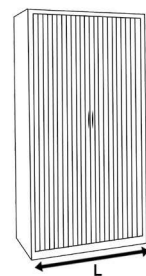
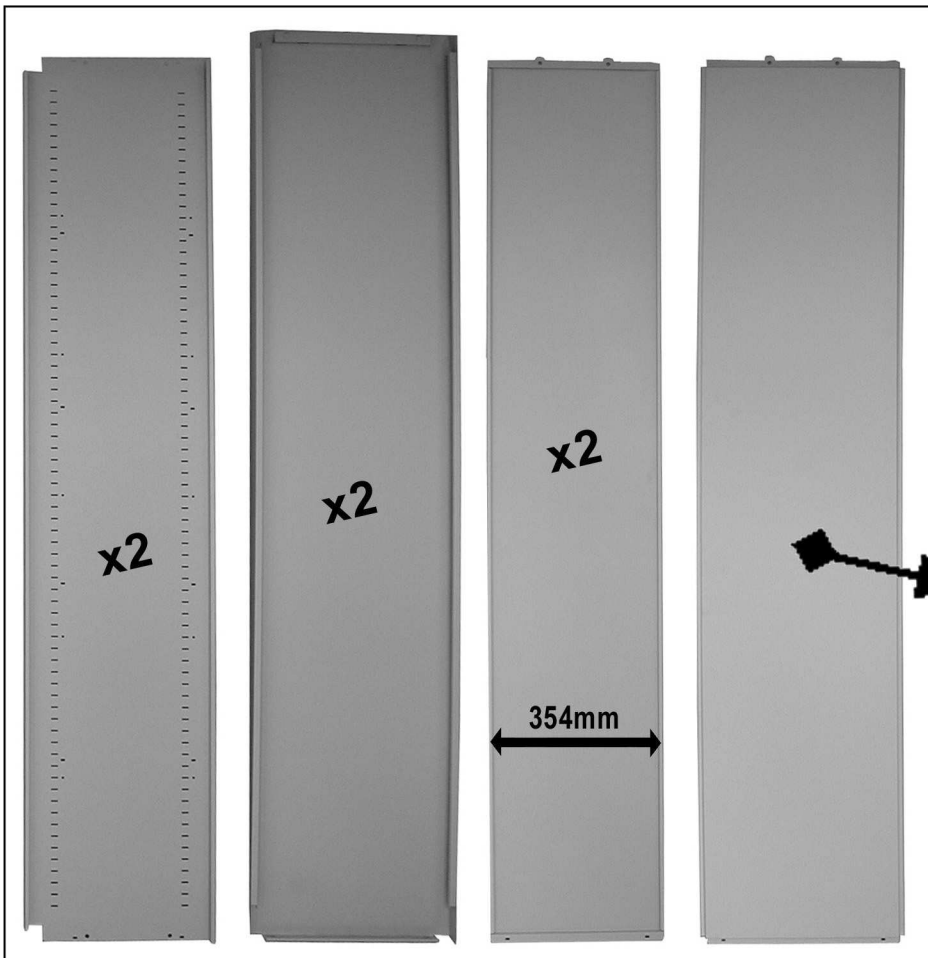

1 x 400 mm	L = 1200 mm
1 x 200 mm	L = 1000 mm
0	L = 800 mm

# CAS DES MONTANTS AVEC DOUBLE PERÇAGES

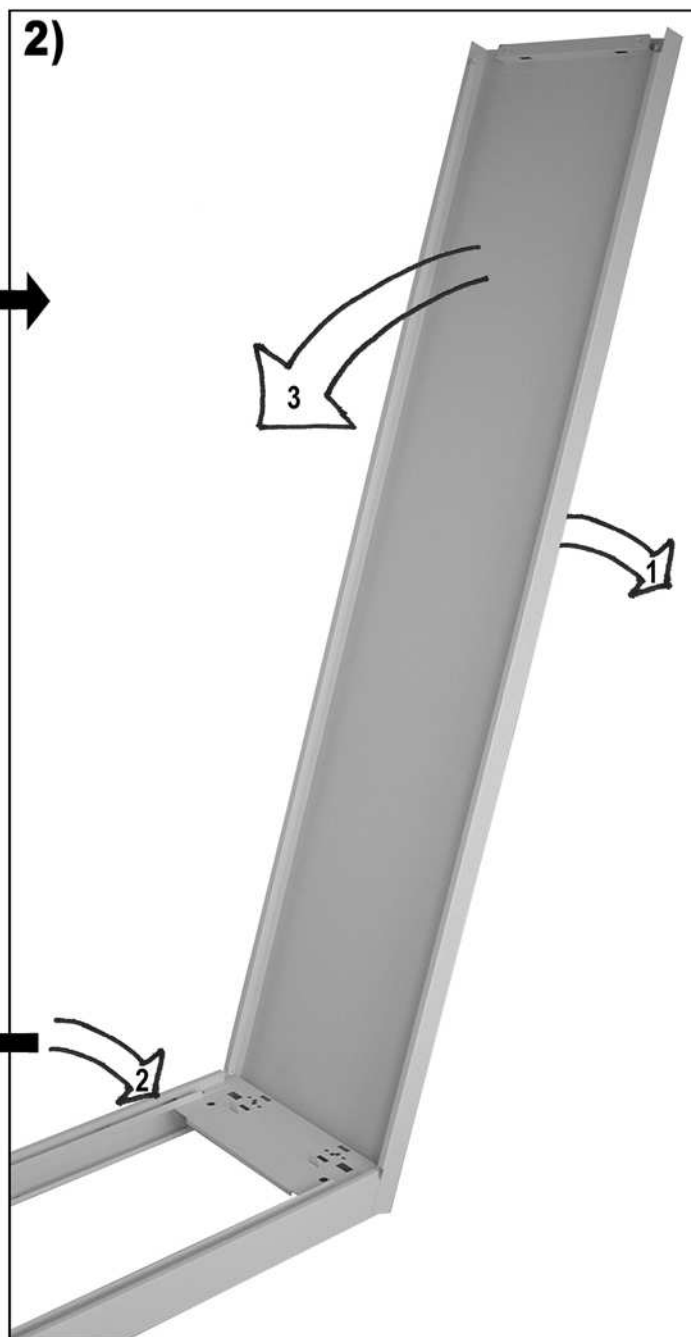
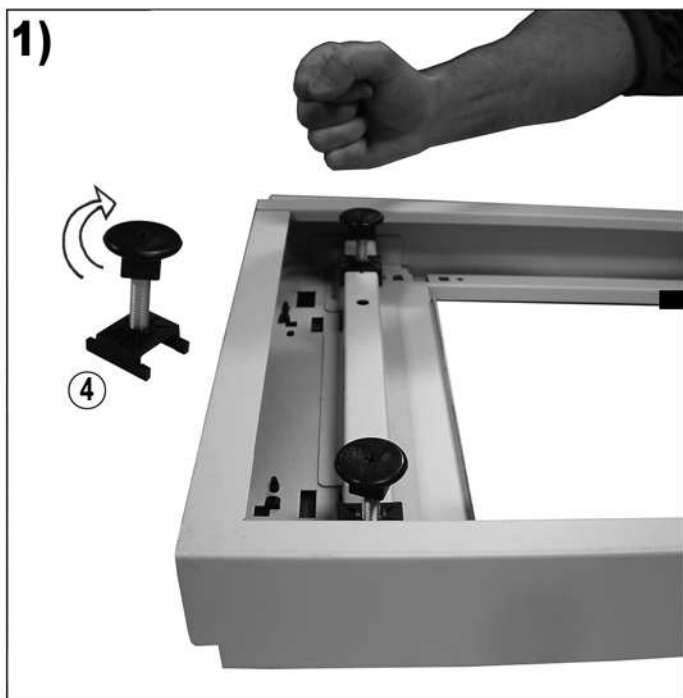

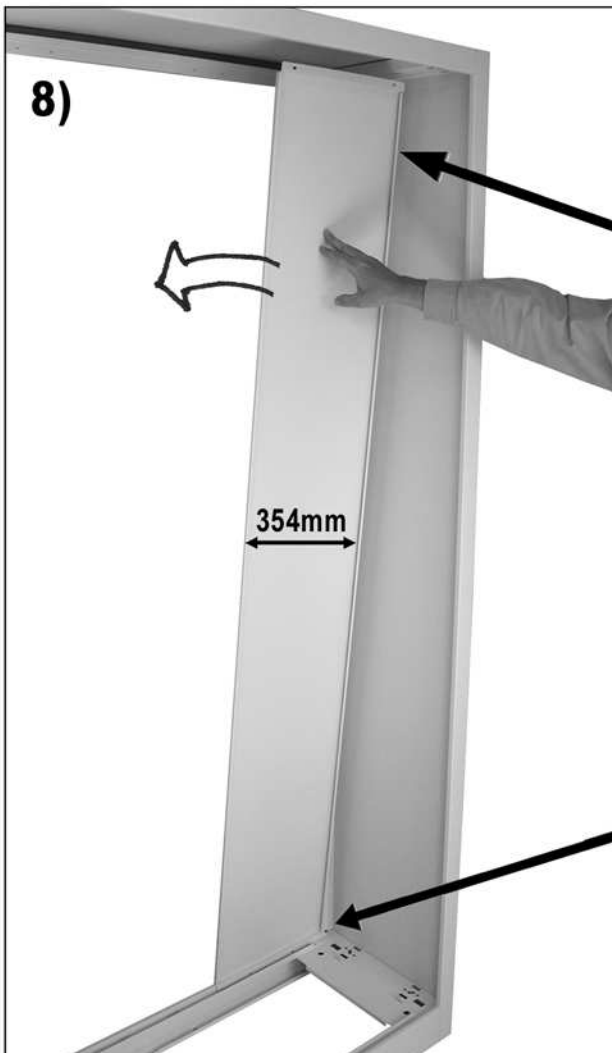
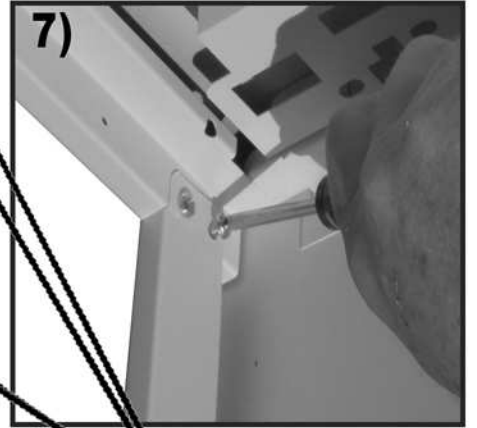
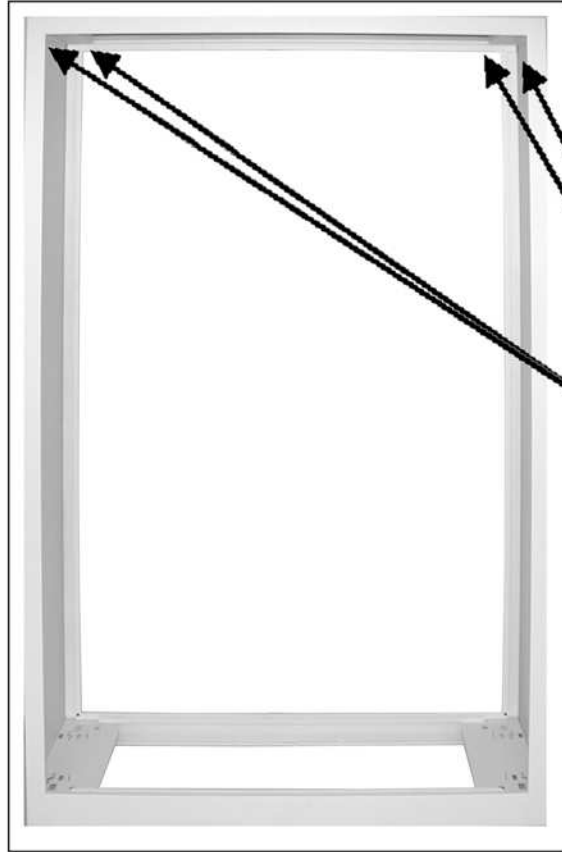

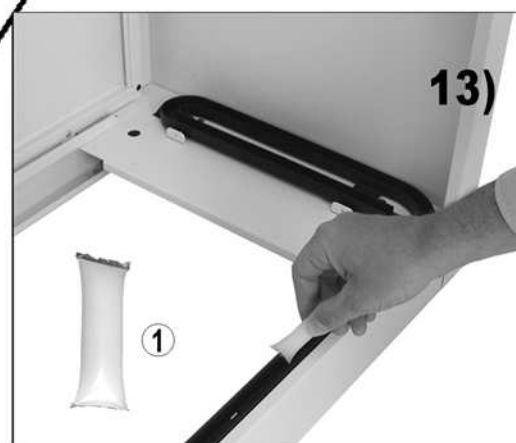
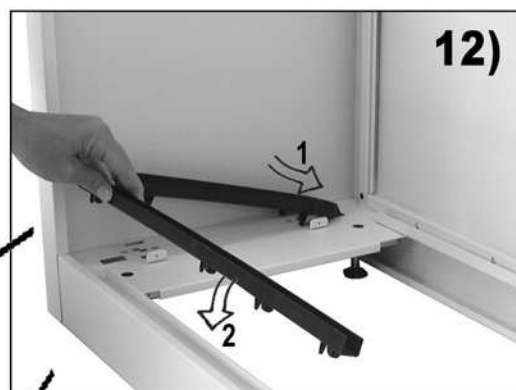
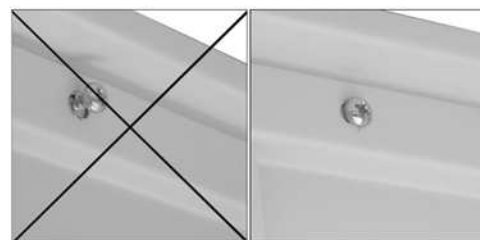

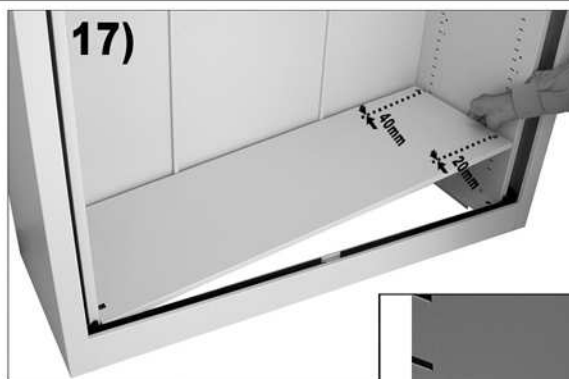
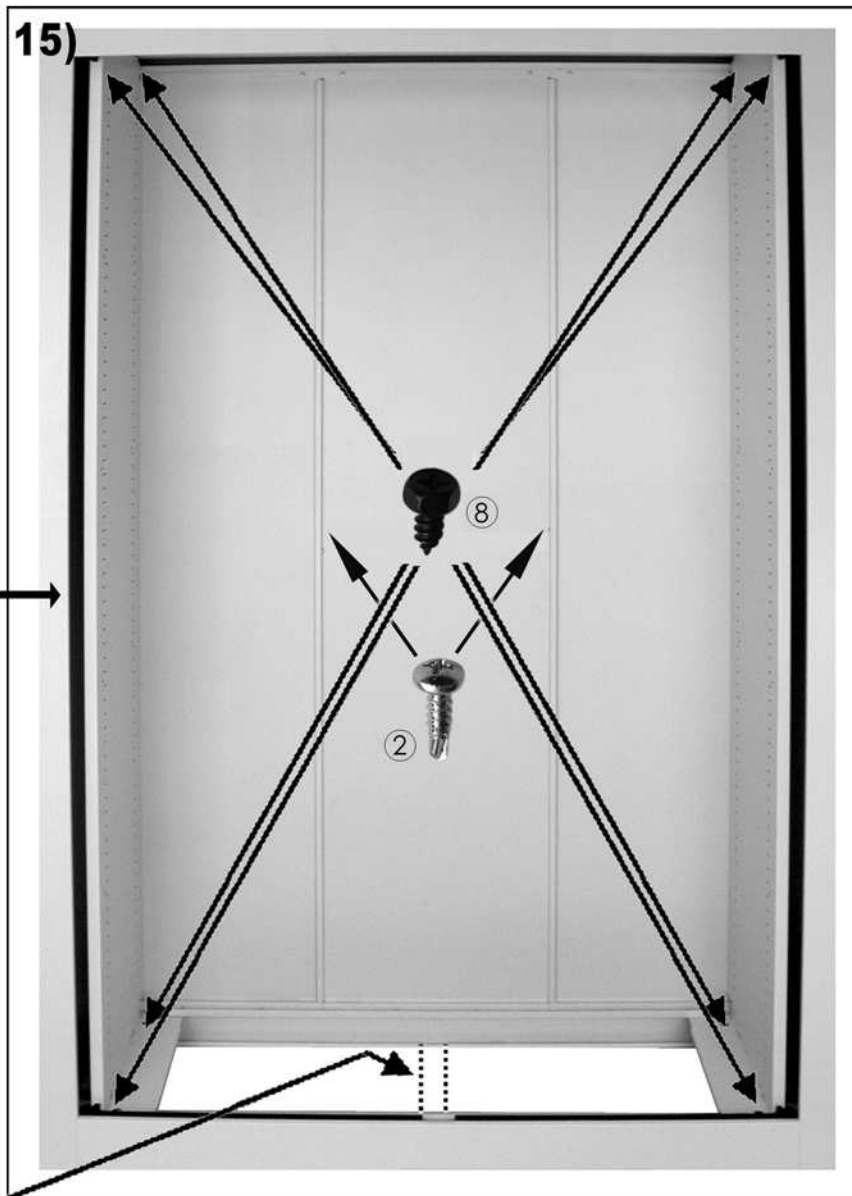
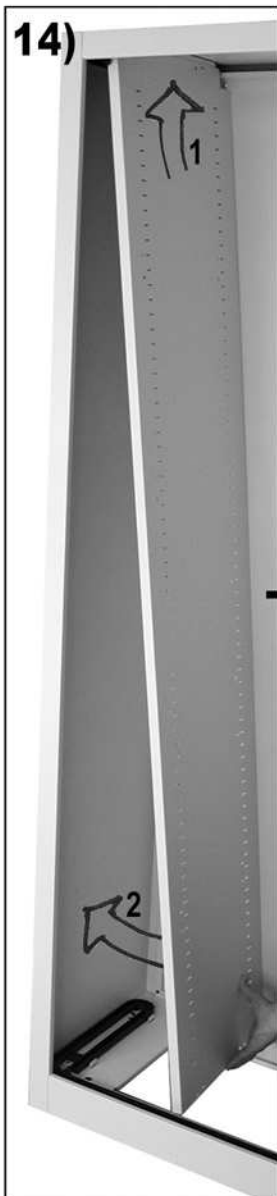

**Le réglage des 4 vérins est IMPERATIF pour la tenue de l'armoire en charge. Le constructeur dégage toute responsabilité en cas de non montage ou non réglage des 4 vérins. Les 4 vérins doivent être en contact avec le sol.**

- Careful adjustment of the 4 levelling screws is essential to the proper performance of the cabinet when loaded. The manufacturer accepts no responsibility for the cabinet if the 4 levelling screws are not fitted or not adjusted. The 4 levelling screws must be in contact with the ground.
- Die 4 Stützzylinder MÜSSEN EINGESTELLT werden, damit der Schrank auch in gefülltem Zustand stabil bleibt. Der Hersteller weist jegliche Verantwortung zurück, falls die Zylinder nicht montiert oder nicht eingestellt worden sind. Die 4 Zylinder müssen den Boden berühren.
- El ajuste de las 4 zapatas resulta IMPERATIVO para la estabilidad del armario cargado. El constructor declina cualquier responsabilidad por no haber montado o ajustado las 4 zapatas. Las 4 zapatas deberan estar en contacto con el suelo.
- Het instellen van de 4 stelvoetjes is NOODZAKELIJK voor de stabiliteit van een volle kast. De fabrikant is niet aansprakelijk voor het fout instellen of het niet monteren van de stelvoetjes. De 4 stelvoetjes moeten in contact zijn met de vloer.
- La regolazione delle 4 staffe è INDISPENSABILE per la tenuta dell'armadio in carico. Il fabbricante declina ogni responsabilità in caso di mancato montaggio e regolazione delle 4 staffe. Le 4 staffe devono essere a contatto con il pavimento.
- O ajuste dos 4 macacos é OBRIGATORIO para a firmeza do armario carregado. O construtor nao se responsabiliza em caso de nao montagem ou nao ajuste dos 4 macacos. Os 4 macacos devem ficar em contacto com o solo.

**18)**



19)

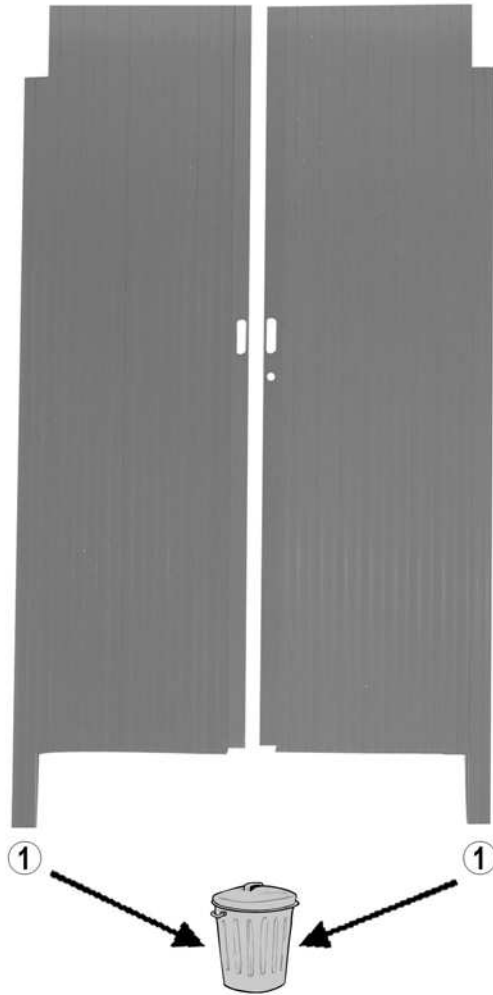

20)

