

0101

0151

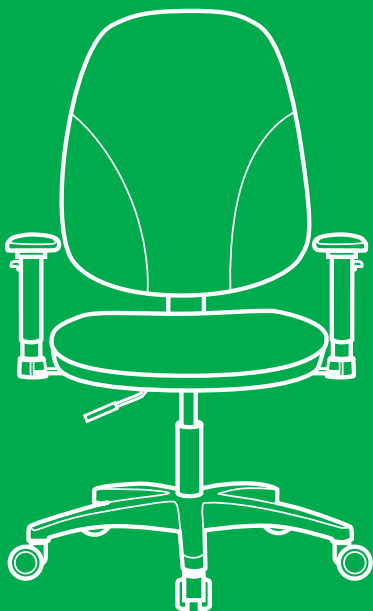

Montage- und Bedienungsanleitung  
Assembly and operating instructions  
Montage e mode d'emploi  
Montage en Gebruiksaanwijzing

# Baseline

**prosedia**

prosedia – eine Marke der

Interstuhl Büromöbel

GmbH & Co. KG

Brühlstraße 21

D 72469 Meßstetten-Tieringen

Phone +49-74 36-871-0

Fax +49-74 36-871-331

info@prosedia.de

www.prosedia.de

Ident. - Nr. 00032698

**www.prosedia.de**

Einfach mehr Stuhl fürs Geld

A



B



C

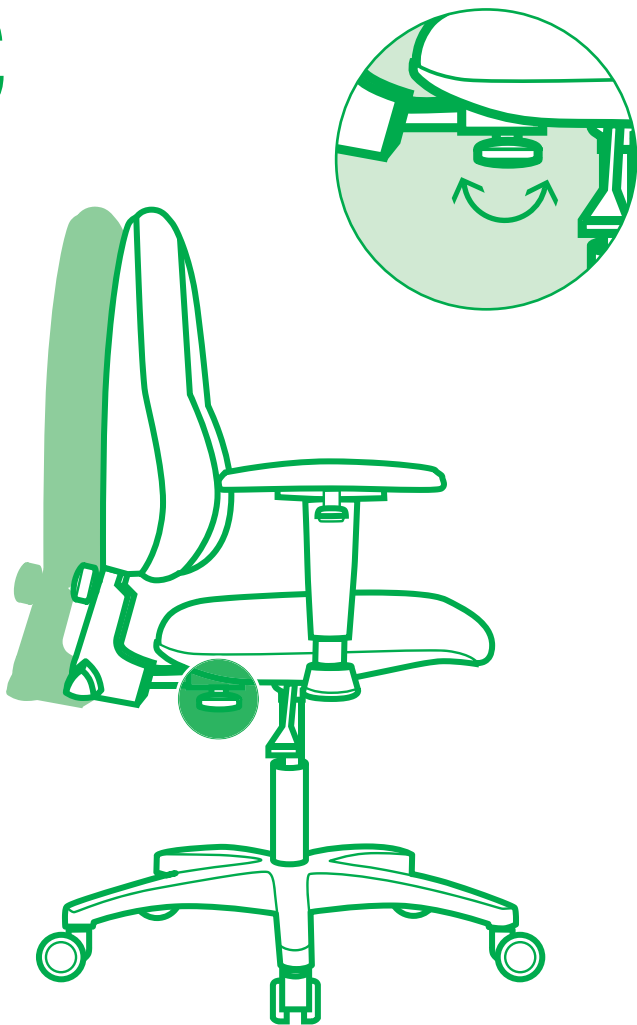

D

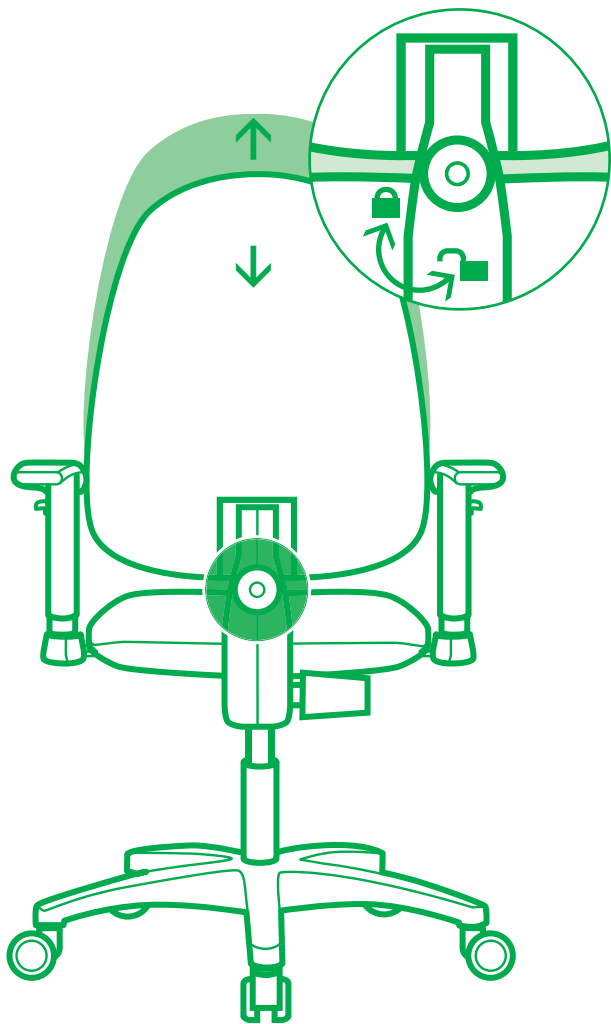

E

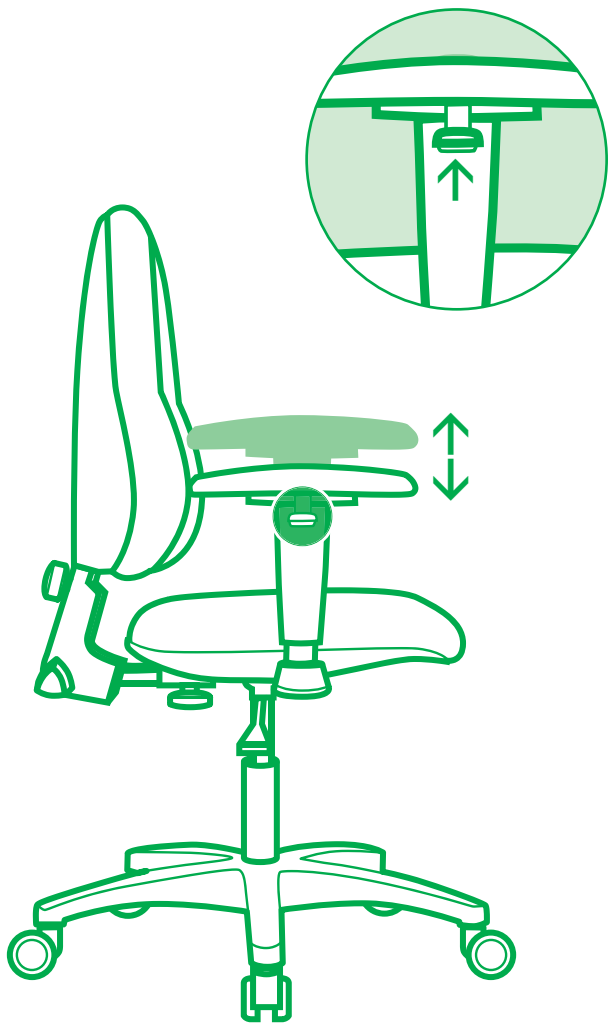

F

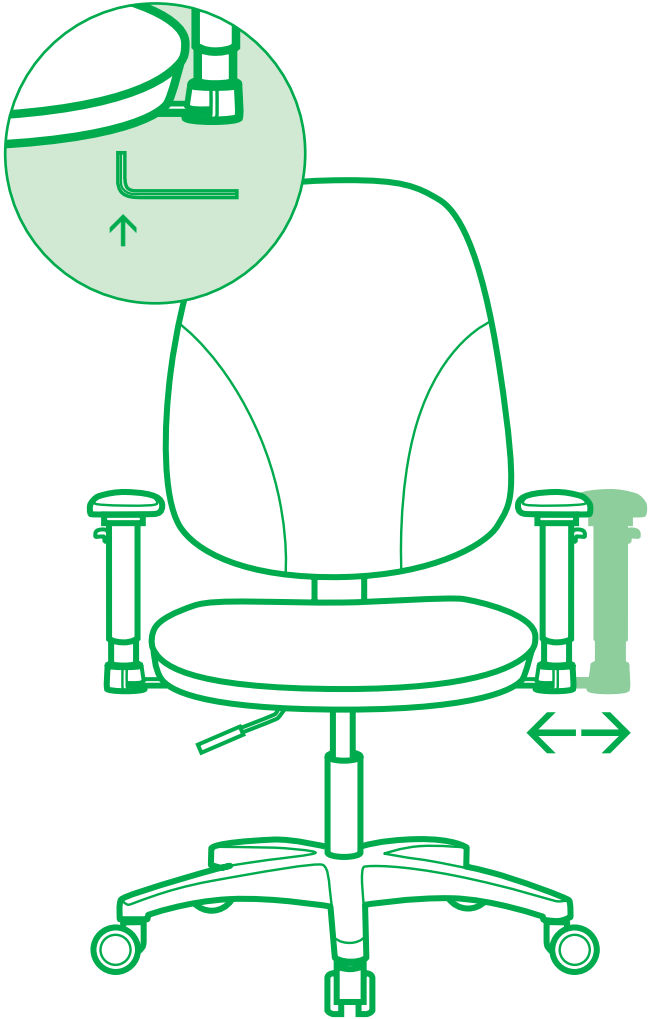



# G

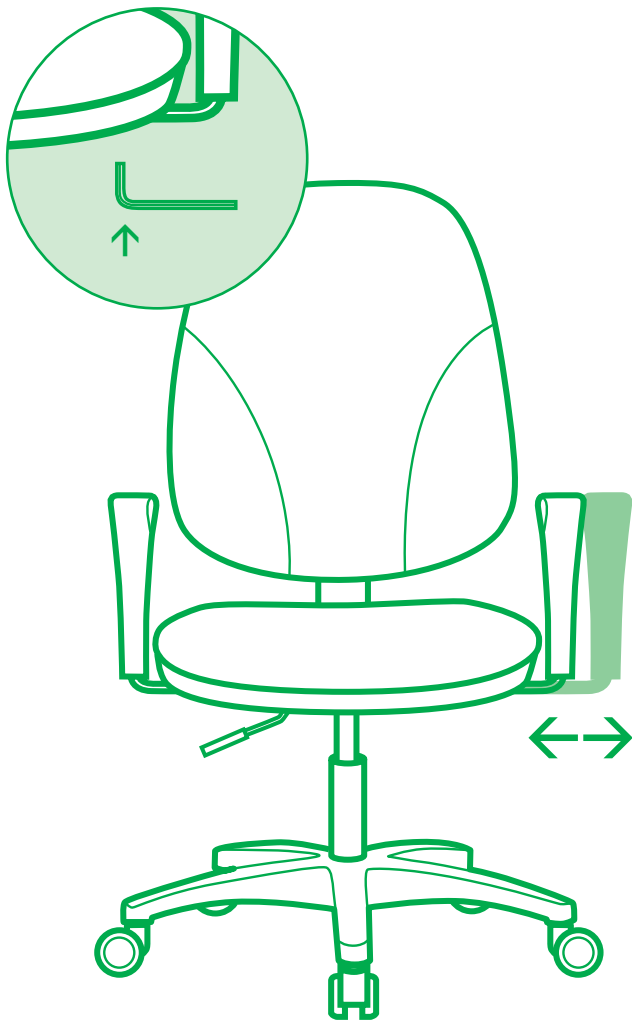

H

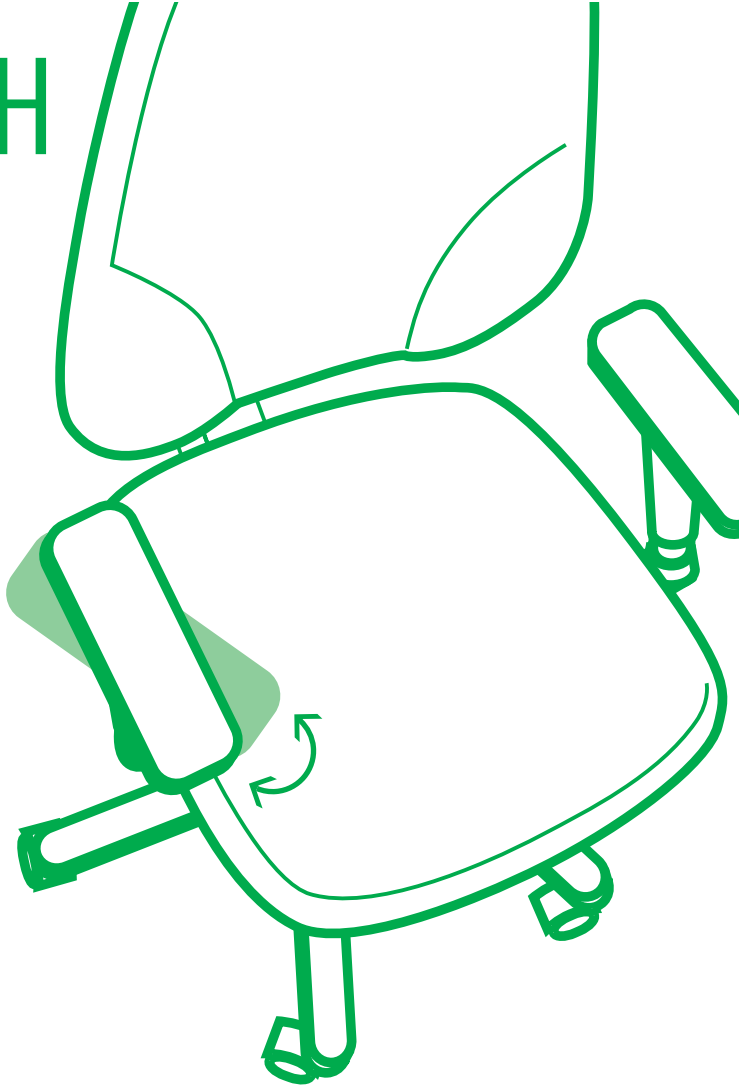

**Vielen Dank, dass Sie sich für einen Baseline von prosedia entschieden haben. Folgen Sie den Anweisungen dieser Gebrauchsanweisung, um alle Funktionen für ergonomisches und komfortables Sitzen zu nutzen.**

Thank you for choosing Baseline from prosedia. Please follow the instructions in order to use all functions for ergonomic and seating comfort.

Merci d'avoir opté pour un siège Baseline de prosedia. Pour profiter pleinement de toutes les fonctions, garanties d'une assise ergonomique et confortable, respectez les consignes délivrées dans la notice d'utilisation.

Hartelijk dank dat u heeft gekozen voor een Baseline van prosedia. Volg de instructies in deze gebruiksaanwijzing om gebruik te maken van alle functies voor ergonomisch en comfortabel zitten.

Muchas gracias por haberse decidido por una Baseline de prosedia. Siga las instrucciones de este manual de uso para aprovechar todas las funciones que permiten sentarse de forma ergonómica y confortable.

Mange tak at du har valgt en Baseline fra prosedia. Følg venligst brugsvejledningen for at udnytte alle funktioner til at sidde ergonomisk og komfortabel i stolen.

Grazie mille per aver scelto l'Baseline di prosedia. Seguite le indicazioni di questa istruzione d'uso, per poter sfruttare tutte le funzioni di una seduta ergonomica e confortevole.

1.

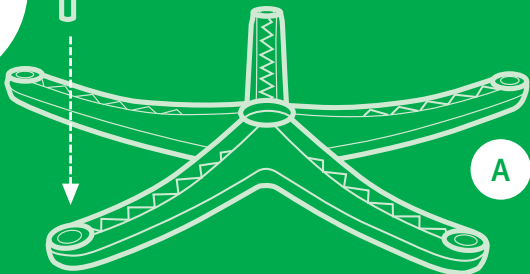
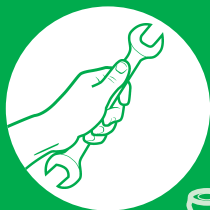

B

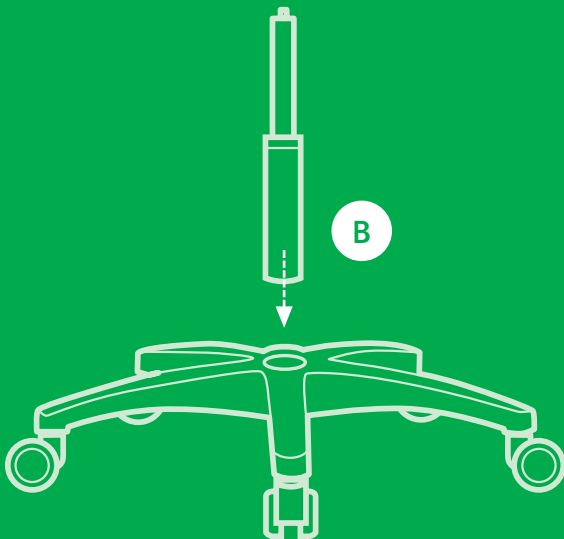

# 2.

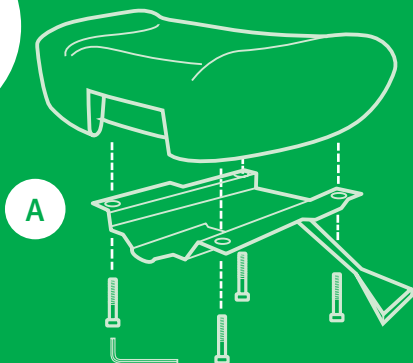

3.

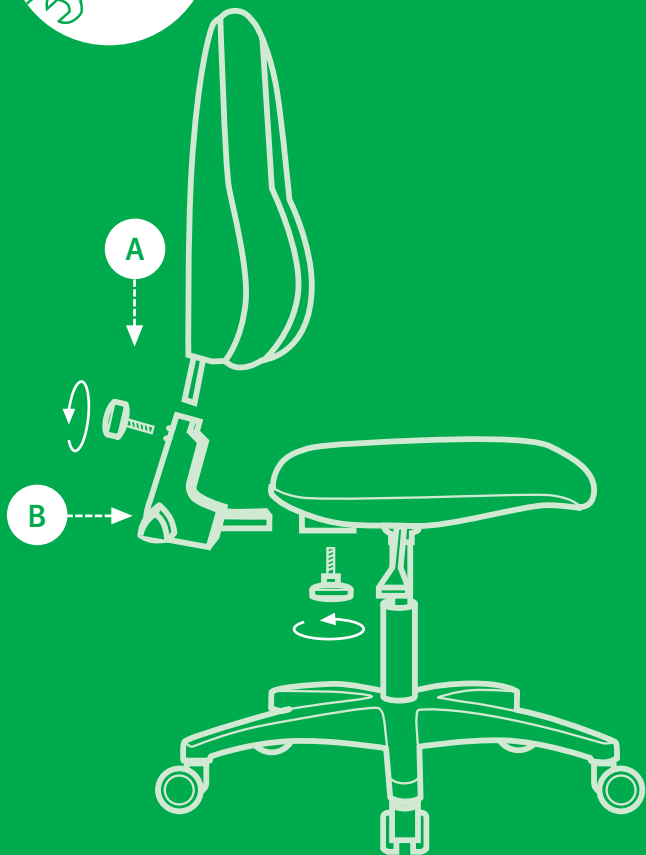

4.

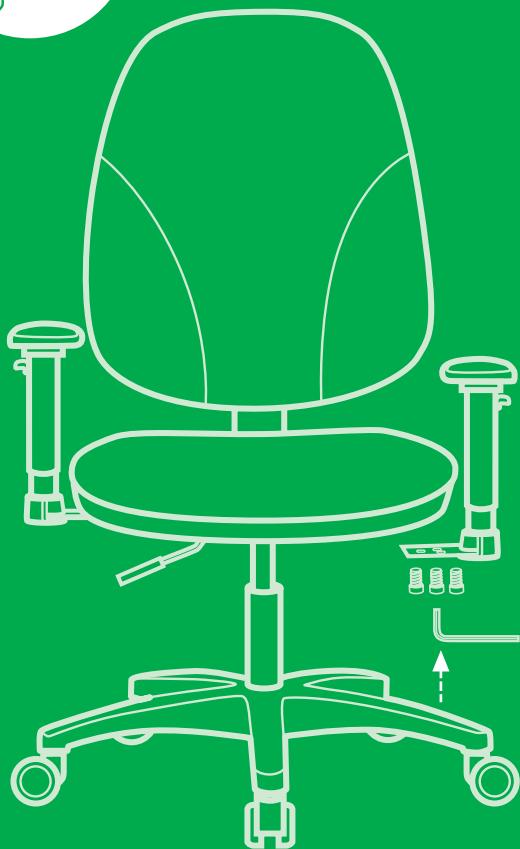
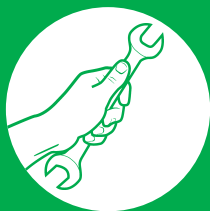

5.

