

INSTRUCTIONS DE MONTAGE / ASSEMBLY INSTRUCTION

LINEA ST04 PF17 MPD170

FL031

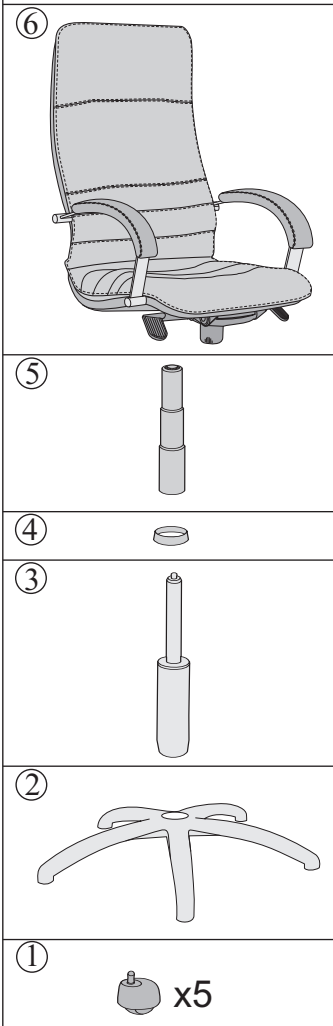

1

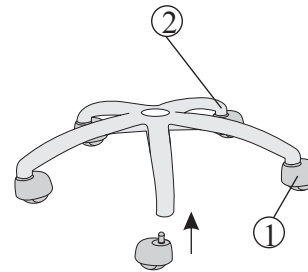

2A

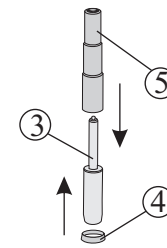

2B

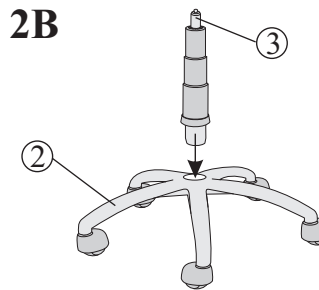

3

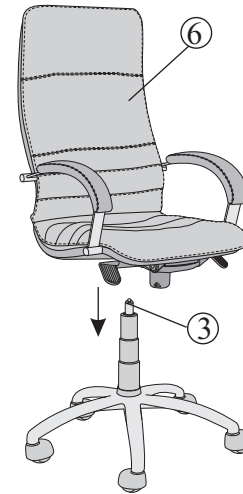

Les différents réglages / Adjustment options

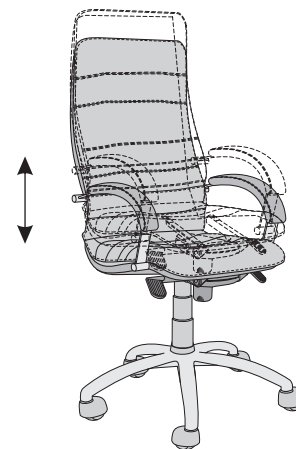

1 Réglage de la hauteur d'assise / Gas height adjustment

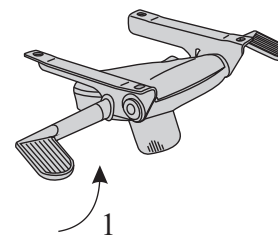

2 Déblocage du dossier / Synchronized free floating movement
3 Blocage du dossier / Synchron movement in locked position

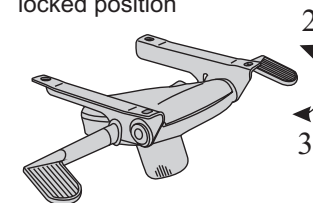

4 Volant de réglage de la tension du dossier / Tension adjustment knob

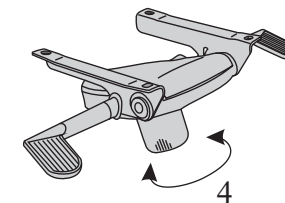

ATTENTION!

Le montage et l'échange de la cartouche de gaz ne peuvent être effectués que par une personne qualifiée.
Exchange and repair of gas-lifts should be carried out by trained specialists only.