

# PIXEL

C'est lorsqu'on est libre de réfléchir de façon ludique qu'émergent les innovations les plus étonnantes. Cette liberté, il appartient à la vie professionnelle de lui redonner sa place, culturelle et spatiale. Et le mobilier doit pouvoir s'y adapter, en toute flexibilité. Pour cela, il y a PIXEL.

Ses cubes intelligents s'assemblent pour créer différentes combinaisons de meubles. Table, rangement, siège, ou tout à la fois : PIXEL joue toujours le jeu. Avec PIXEL, les configurations requises sont vite installées, rangées ou remodelées, laissant place à la nouveauté.



## DESCRIPTION DU PRODUIT

### PIXEL BOX FERMÉ

Élément de base.

- contreplaqué de pin non traité de 12 mm
- vérin de réglage : plastique, noir
- poignée : rabattable, acier noir

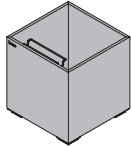

### PIXEL BOX AVEC OUVERTURES LATÉRALES

En option.

- taille des découpes :  
hauteur 280 mm, largeur 130 mm

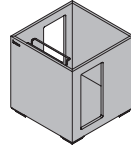

### PIXEL BOX AVEC GRANDE OUVERTURE LATÉRALE

En option.

- taille des découpes :  
hauteur 280 mm, largeur 260 mm

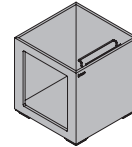

### PIXEL POD

1/2 PIXEL Box.

- contreplaqué de pin non traité de 12 mm
- vérin de réglage : plastique, noir
- poignée : rabattable, acier noir

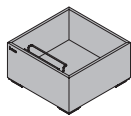

### PIXEL TRAY

Élément intermédiaire et surface de dépose.

- contreplaqué de pin non traité de 12 mm
- vérin de réglage : plastique, noir

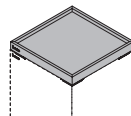

### PIXEL TOP 19 MM OU 38 MM

- plateau en particules de mélamine de 19 mm ou panneau léger en nid d'abeille de 38 mm
- avec surface en mélamine de 38 mm
- couleurs & matériaux : MW blanc

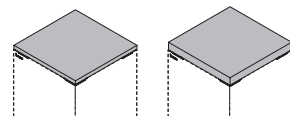

### PIXEL MOBILE TRAY

Plaque de base sur roulettes.

- contreplaqué de pin non traité de 12 mm
- 4 roulettes orientables avec bloqueurs
- base pour PIXEL Tower et PIXEL Mobile Lounge

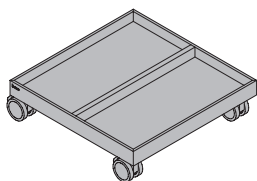

### PIXEL TRAY 180

Plaque multifonctions.

- contreplaqué de pin non traité de 12 mm
- vérin de réglage : plastique, noir
- relie 5 longueurs de box
- élément intermédiaire ou final horizontal
- en option avec crochet de fixation

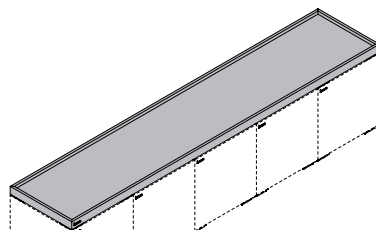

### PIXEL TOP 180

- plateau en particules de mélamine de 19 mm
- panneau léger en nid d'abeille de 38 mm avec surface en mélamine
- couleurs & matériaux : MW blanc
- relie 5 longueurs de box
- élément final horizontal
- en option avec crochet de fixation

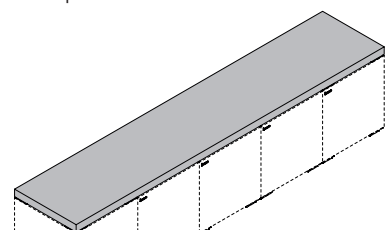

### PIXEL PAD

Coussin.

- caoutchouc cellulaire noir de 20 mm
- version ignifuge

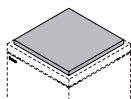

### PIXEL SOFT PAD

Coussin.

- noyau en mousse polyuréthane version ignifuge conforme à la norme BS 5852 partie 2, source d'allumage 5 (Crib 5)
- revêtement en tissu, P0 à P4 de la collection Bene
- face inférieure toujours tissu Corovin, noir
- par lot de 3 coussins (du même modèle)

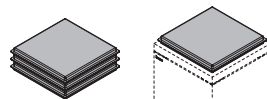

## PRINCIPE DE FONCTIONNEMENT

### Assemblage en ligne

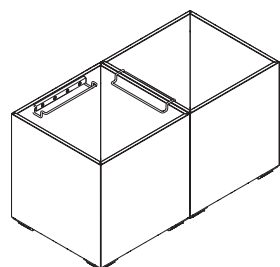
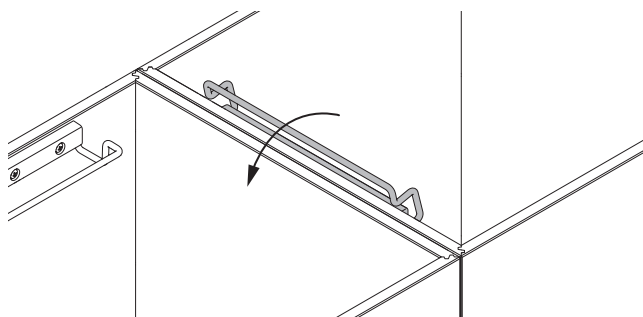

### Empilement

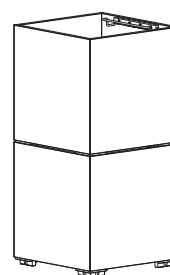
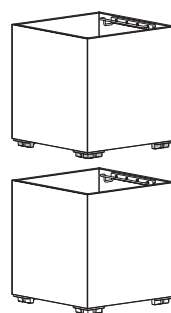
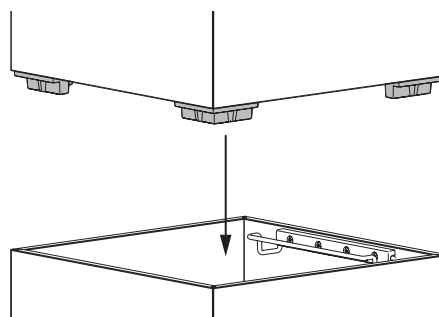

Joint de 6 mm

## TRAME DE HAUTEUR

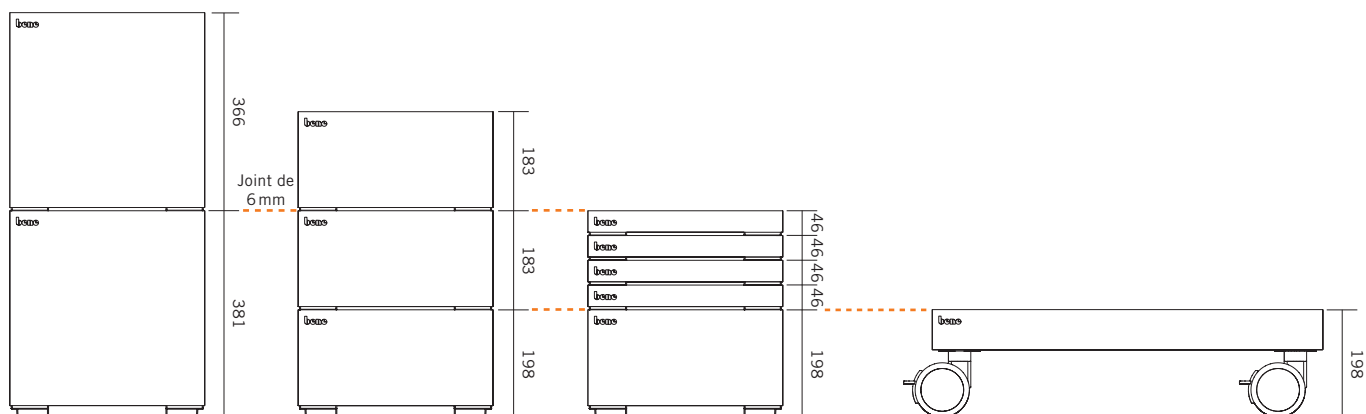

## OPTIONS

### CROCHET DE FIXATION PIXEL POUR PIXEL TOP 180 ET PIXEL TRAY 180

Crochet de fixation rabattable. Pour la fixation de PIXEL Top 180 et de PIXEL Tray 180 sur la PIXEL Tower. Peut s'installer ultérieurement.

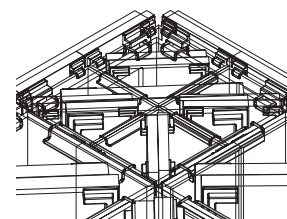
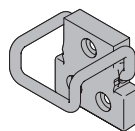
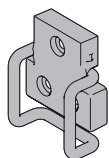

## APERÇU & DIMENSIONS

**PIXEL BOX  
FERMÉE**

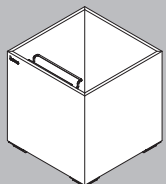

L : 360  
P : 360  
H : 381

**PIXEL BOX  
AVEC OUVERTURES LATÉRALES**

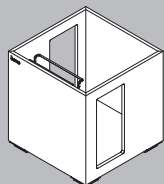

L : 360  
P : 360  
H : 381

**PIXEL BOX AVEC  
GRANDE OUVERTURE LATÉRALE**

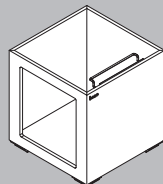

L : 360  
P : 360  
H : 381

**PIXEL POD**

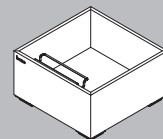

L : 360  
P : 360  
H : 198

**PIXEL TRAY**

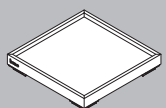

L : 360  
P : 360  
H : 61

**PIXEL TOP 19MM + 38MM**

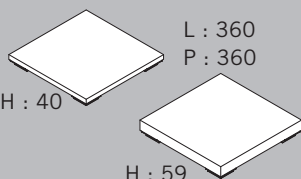

L : 360  
P : 360  
H : 40  
H : 59

**PIXEL PAD**

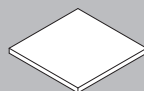

L : 320  
P : 320  
H : 20

**PIXEL SOFT PAD**

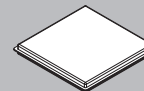

L : 340  
P : 340  
H : 40

**PIXEL TRAY 180**

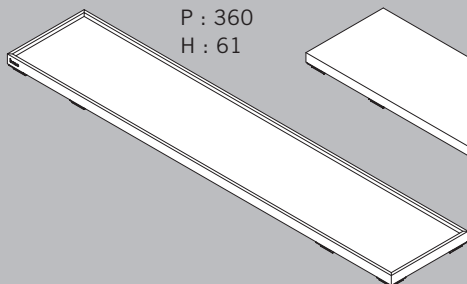

L : 1804  
P : 360  
H : 61

**PIXEL TOP 180**

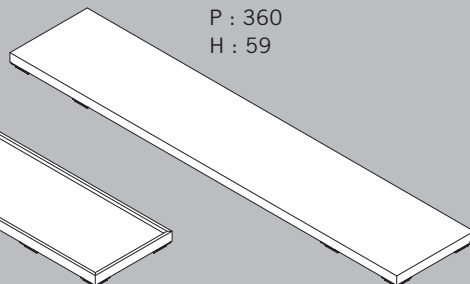

L : 1804  
P : 360  
H : 59

**PIXEL MOBILE TRAY**

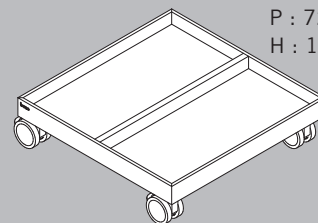

L : 721  
P : 721  
H : 198

Dimensions en mm

## COMBINAISONS POSSIBLES - #01 PIXEL TOWER

PIXEL permet de multiples possibilités d'aménagement. La PIXEL Tower comprend le kit de base regroupant des PIXEL Boxes, Pods, Tops, Trays et Soft Pads à partir desquels il est possible de réaliser de nombreuses configurations.

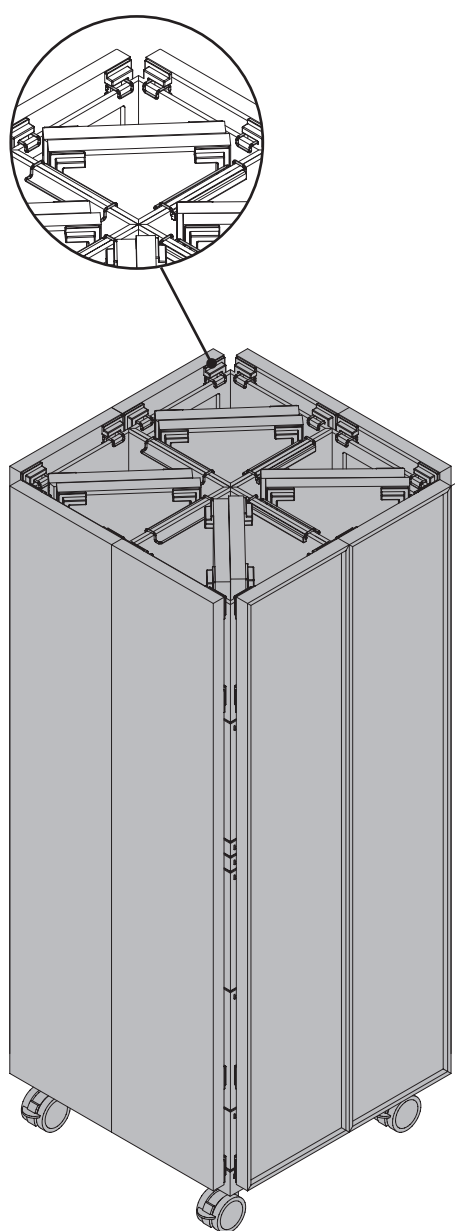
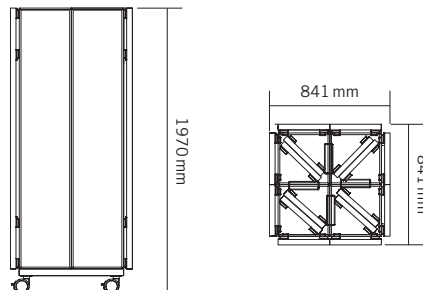
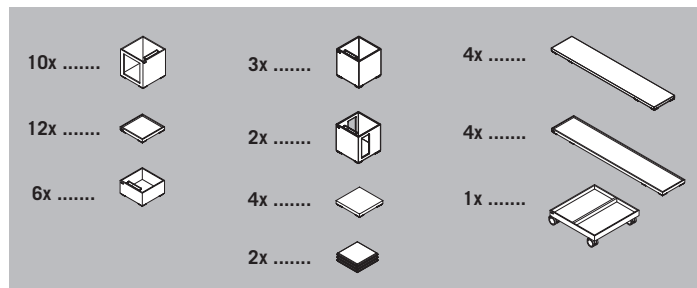

## COMBINAISONS POSSIBLES

### #02 TABOURET

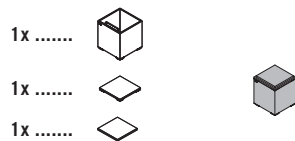

### #03 TABOURET

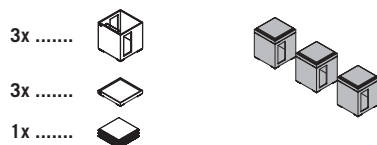

### #04 BANC

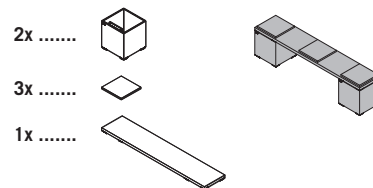

### #05 TABLE POUR POSITION ASSISE

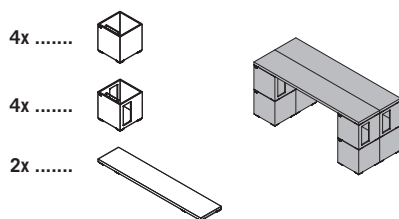

### #06 TABLE POUR POSITION DEBOUT

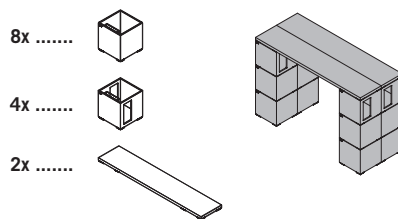

### #07 ESTRADE

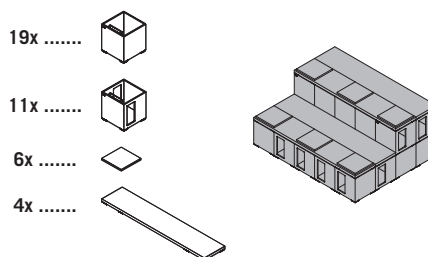

### #08 LOUNGE

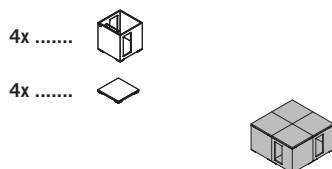

### #09 PUPITRE

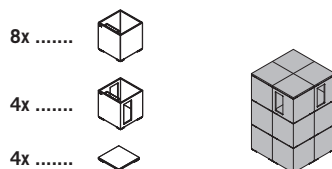

### #10 MOBILE LOUNGE

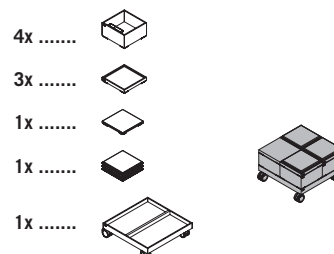

### #11 PUPITRE SUR ROULETTES

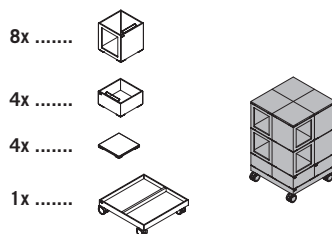

### #12 BANQUETTE

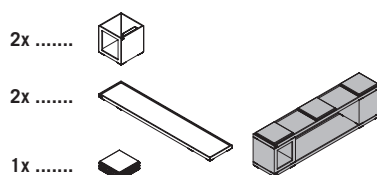

### #13 ÉTAGÈRE

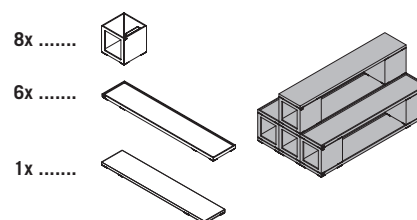

### #14 ÉTAGÈRE

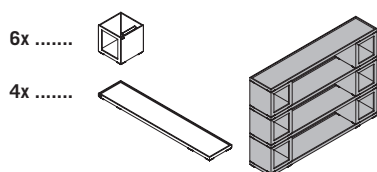

### #15 ÉTAGÈRE

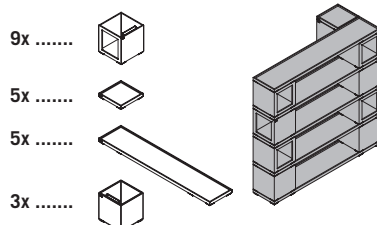

### #16 ÉTAGÈRE

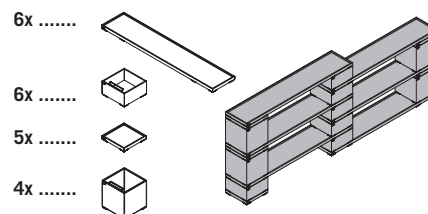

## COMBINAISONS POSSIBLES

#17 COMBINAISON DE TABLES

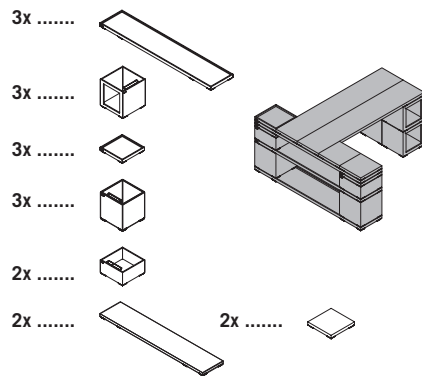

#18 COMBINAISON DE TABLES

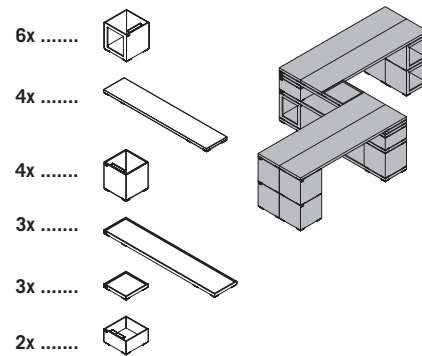

#19 COMBINAISON DE TABLES

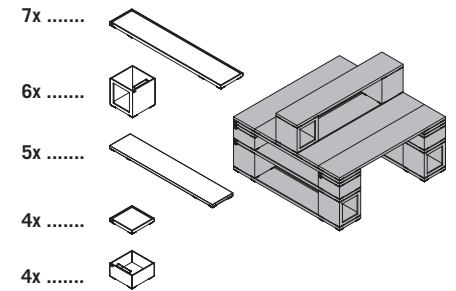

#20 COMBINAISON DE TABLES

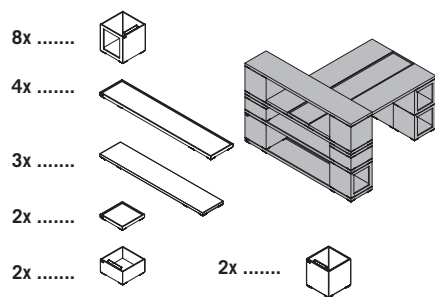

#21 COMBINAISON DE TABLES

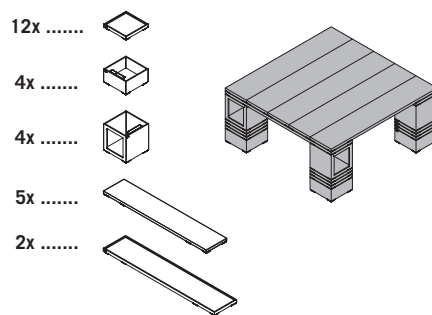

#22 COMBINAISON DE TABLES

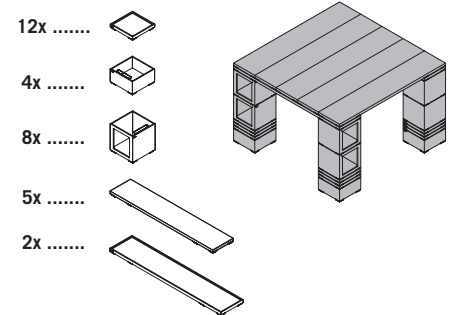

#23 ÉTAGÈRE

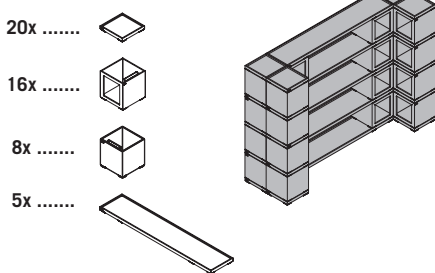

#24 BAR

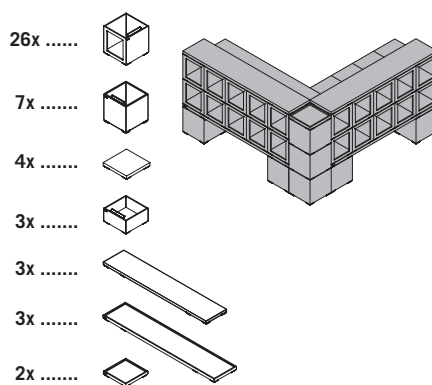

#25 COMBINAISON BAR ET TABLES

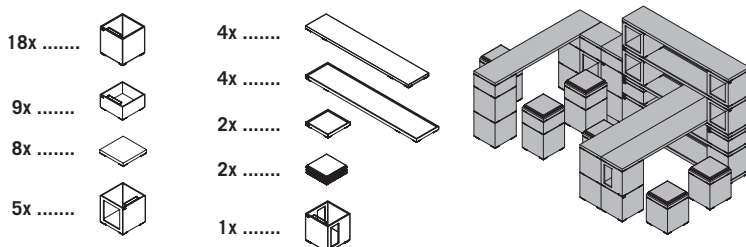

## INSTRUCTIONS DE SÉCURITÉ

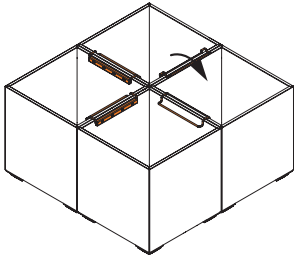

Pour garantir la stabilité, fixer en rabattant la poignée.

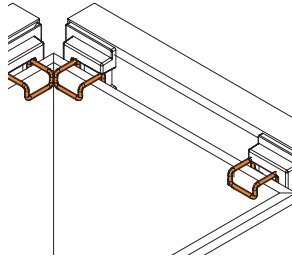

Fixation PIXEL TOP 180 et PIXEL Tray 180.

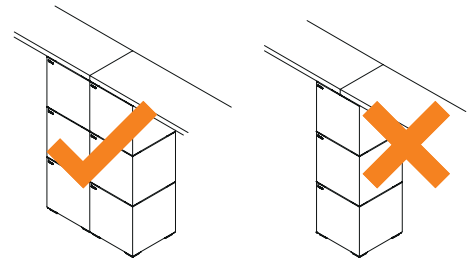

Assemblage en ligne du PIXEL Tray 180/PIXEL Top 180

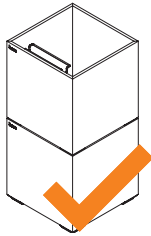

Empiler correctement les PIXEL Boxes.

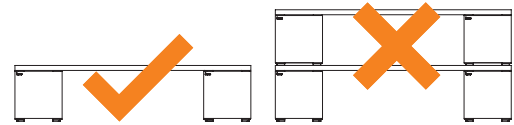
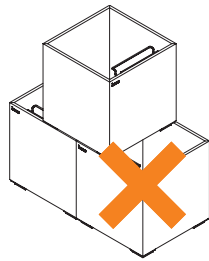

Le PIXEL Top n'autorise pas d'empilement supplémentaire. Pour continuer l'empilement, utiliser des PIXEL Trays.

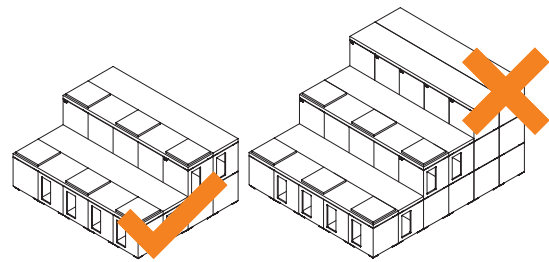

Une utilisation comme estrade n'autorise pas de troisième niveau.

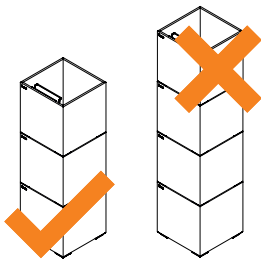

Ne pas empiler plus de trois PIXEL Boxes.



Ne pas monter sur un PIXEL Mobile Tray. Ne s'asseoir sur la Mobile Lounge qu'une fois les roulettes bloquées.

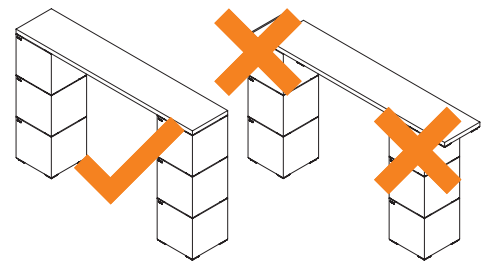

Poser le PIXEL Top 180 et le PIXEL Tray 180 au même niveau !

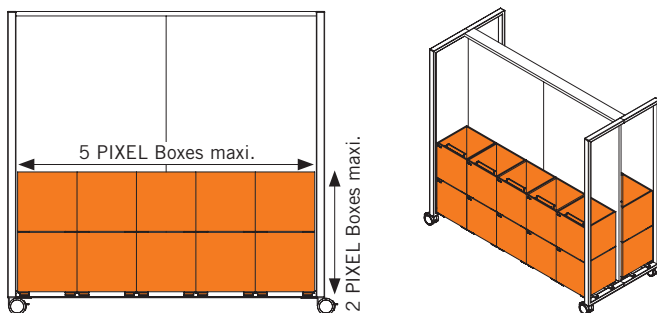

Utilisation du support PIXEL dans le modèle en H du FRAME\_S Board 10 cubes PIXEL Box par côté / maximum de 20 cubes PIXEL Box au total

Charge maximale : 200 kg

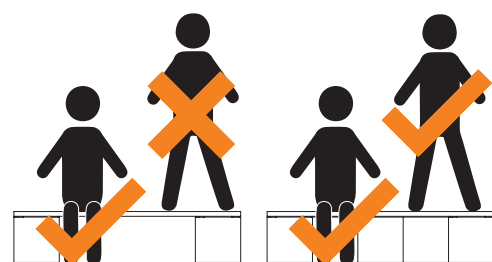

Assis / debout sur des configurations PIXEL



## INSPIRATIONS

**INSPIRATION #01**  
env. 65 m<sup>2</sup>/env. 10 à 18 personnes

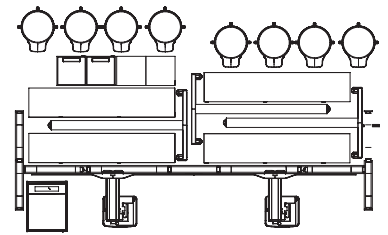
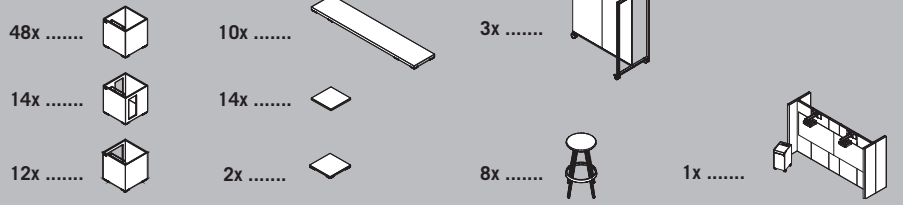

### DECOUVRIR

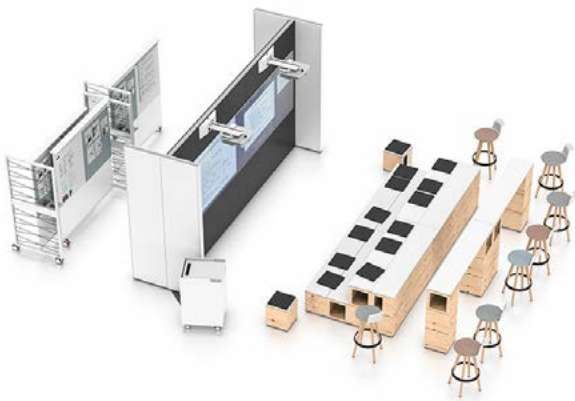

### CREER









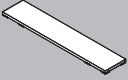
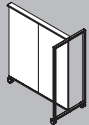

### PARTAGER



## INSPIRATIONS

**INSPIRATION #02**  
env. 40 m<sup>2</sup>/env. 8 à 10 personnes

34x .....		6x .....		2x .....		1x .....	
8x .....		9x .....		3x .....		1x .....	
8x .....		6x .....		4x .....			

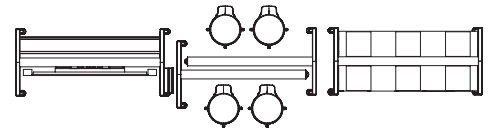

### DECOUVRIR



### CREER





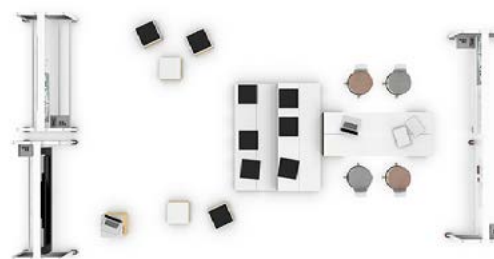



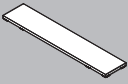

### PARTAGER

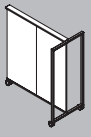

## INSPIRATIONS

**INSPIRATION #03**  
env. 25 m<sup>2</sup>/env. 4 à 6 personnes

12x .....		3x .....		2x .....		1x .....	
4x .....		5x .....					
4x .....		2x .....		2x .....		1x .....	

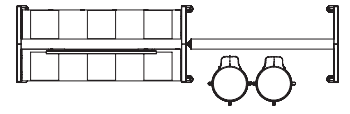

### DECOUVRIR



### CREER



### PARTAGER



## INSPIRATIONS

**INSPIRATION #04**  
env. 20 m<sup>2</sup>/env. 2 à 4 personnes

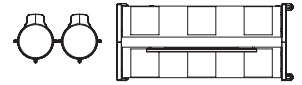
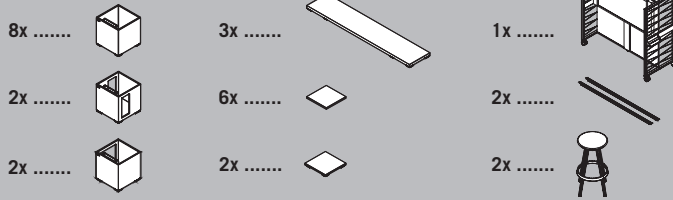

### DECOUVRIR



### CREER



### PARTAGER



## INSPIRATIONS

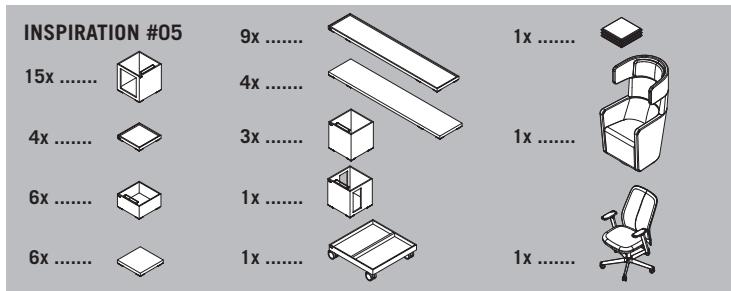

## INSPIRATIONS

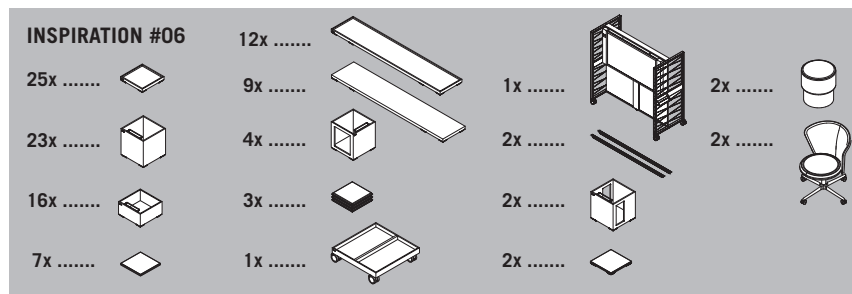



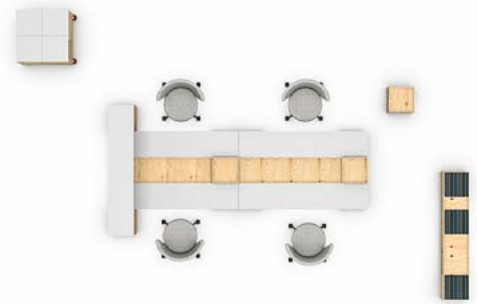
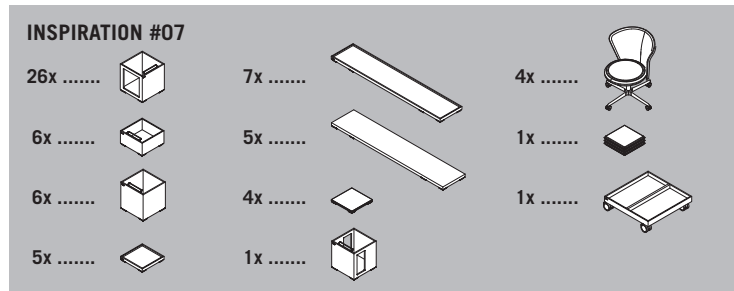







## INSPIRATIONS

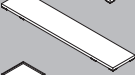

## INSPIRATIONS

**INSPIRATION #08**

29x .....		21x .....		1x .....	
18x .....		8x .....		1x .....	
11x .....		4x .....			
8x .....		2x .....			

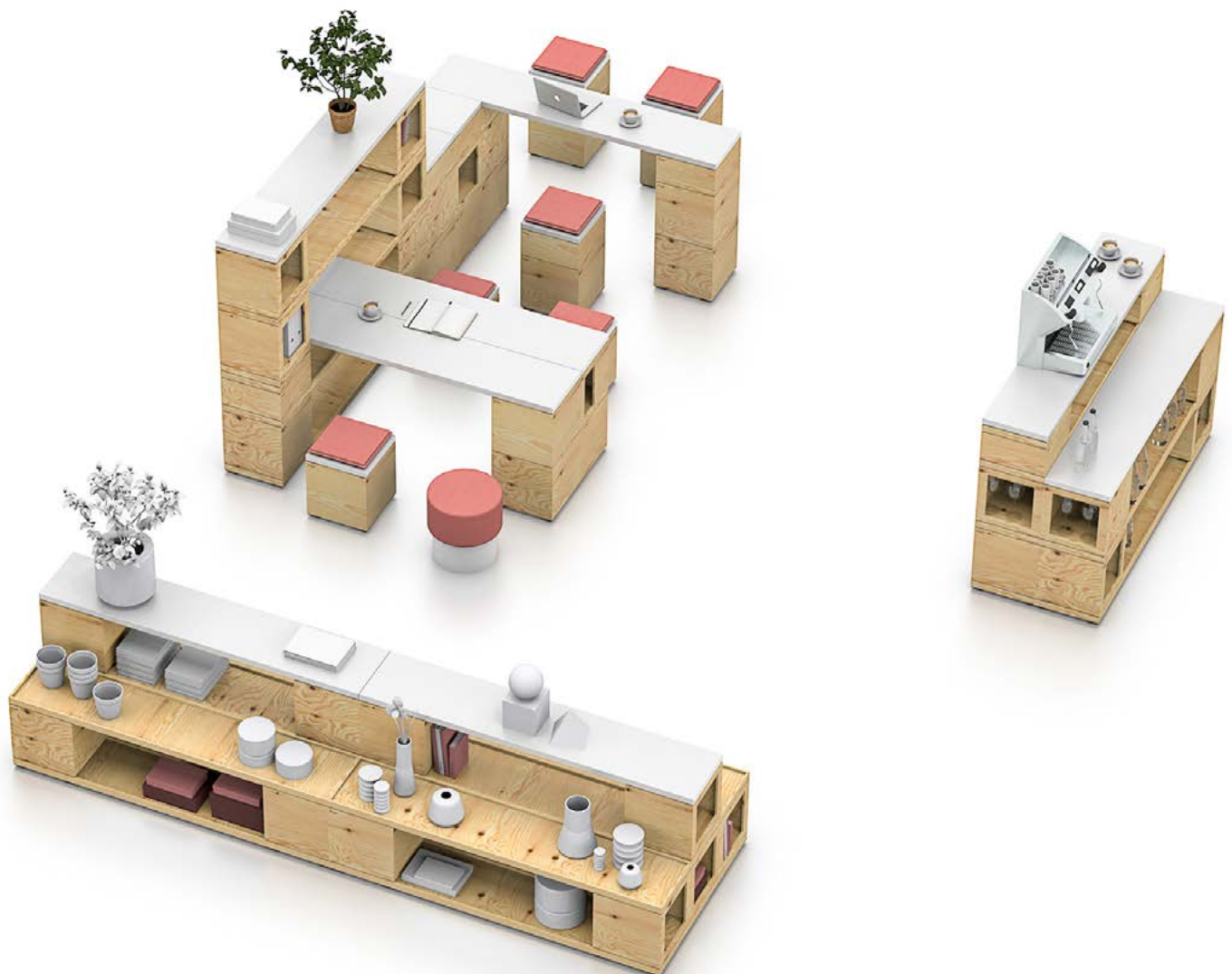
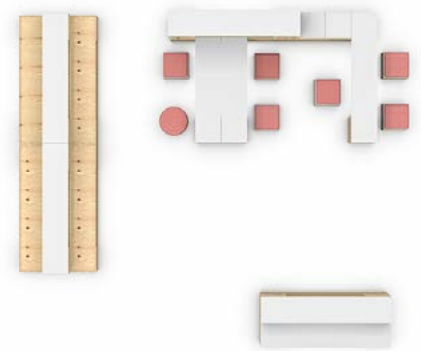



## COULEURS & MATERIAUX

Les matériaux et couleurs suivants sont disponibles pour ce produit.

- . . . . . disponible
- . . . . . non disponible

Surface	PIXEL Box	PIXEL Pod	PIXEL Tray + Tray 180	PIXEL Wheel Tray
Pin naturel non traité	•	•	•	•

Surface	PIXEL Top + Top 180	PIXEL Pad	PIXEL Soft Pad
Tissu (PO-P4)	-	-	•
Catégorie de mélamine 1: couleurs de base (MW blanc)	•	-	-
Caoutchouc cellulaire (noir)	-	•	-

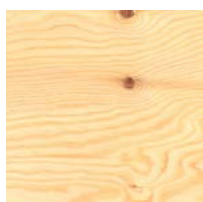

Naturel non traité

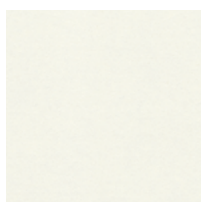

MW blanc

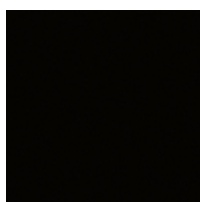

Noir

### PIXEL Soft Pad

Différentes collections de tissus sont disponibles comme matériau de revêtement : Urban Plus, Xtreme Plus, Inn, Step, Step Melange, Patina, Remix, Europost, Clara, Mainline Flex, Divina, Steelcut, Fiord, Stamskin Top, Sunbrella 3, Hallingdal, Steelcut Trio, Divina Melange, Divina MD, Greenwich Uni. De plus amples informations sur les différentes collections de tissus se trouvent sur [www.bene.com](http://www.bene.com).

### Information

Le bois est un produit naturel pouvant présenter des différences de teinte et des irrégularités liées à la croissance de l'arbre. Des variations de texture et de teinte entre les parties d'un meuble ou entre différents meubles du même matériau sont possibles dans la mesure où elles sont usuelles et relèvent de la nature des matériaux utilisés ; elles ne constituent pas de motifs de réclamation.

Nous avons délibérément choisi d'utiliser pour PIXEL du contreplaqué de pin brut, dont le parement peut présenter des noeuds ainsi que des fissures qui lui confèrent une singularité esthétique. Cette caractéristique du design est une preuve d'authenticité et ne peut donc pas faire l'objet de réclamations.

## LES PRODUITS BENE SONT FAITS POUR DURER

Bene joue un rôle précurseur en matière de gestion responsable de l'environnement. Tous les domaines d'activité de l'entreprise sont concernés : éco-conception, approvisionnement des matières, fabrication, logistique, cycle de vie et recyclage des produits. Bene définit l'écologie comme un élément principal de sa stratégie responsable et durable d'entreprise, considérant les règles légales en vigueur comme des exigences minimales et aspirant à une protection plus importante et plus durable de l'environnement. Le grand principe que suit Bene pour sa politique environnementale est : **Prévenir – Réduire – Recycler – Éliminer**.

### PIXEL – NORMES ECOLOGIQUES

- 99,0% des composants sont recyclables
- 94,3% des matières premières sont d'origine végétale
- 1,61% des matériaux de production sont issus de matériaux recyclés (1,61% après consommation, 0,00%, avant consommation)
- Utilisation de 1,61% de matériaux de production issus de matériaux recyclés selon le système LEED (1,61% après consommation, 0,00%, avant consommation)
- Un design utilisant un minimum de ressources
- Utilisation de bois certifiés (chaîne de contrôle)
- Utilisation de matériaux certifiés sans substances nocives
- Pas d'utilisation de PVC, de matière collante, de chrome, de plomb ou de mercure
- Les pièces peuvent être triées selon le type de matériau
- Matériaux recyclables et contribution positive au bilan carbone (en moyenne 10,7 kg de CO<sub>2</sub>)

## PIXEL ET POINTS LEED

LEED (Leadership in Energy and Environmental Design) est un système de notation des constructions « écologiques », mis au point par l'U.S. Green Building Council. Norme de référence internationalement reconnue, LEED définit une série de directives en matière de construction respectueuse de l'environnement, économe en ressources et durable. PIXEL joue un rôle important pour l'obtention d'une certification LEED. Jusqu'à 6 points sont disponibles d'après le barème LEED 2009 pour l'aménagement intérieur des espaces, voir le détail ci-dessous :

MR Crédit 4	Part de recyclage	jusqu'à 2 points
MR Crédit 5	Matériaux d'origine locale	jusqu'à 2 points
MR Crédit 7	Bois certifié	jusqu'à 1 point
IEQ Crédit 4,5	Matériaux à faible teneur en substances nocives	jusqu'à 1 point

### PIXEL EST CONSTITUE DES MATERIAUX SUIVANTS :

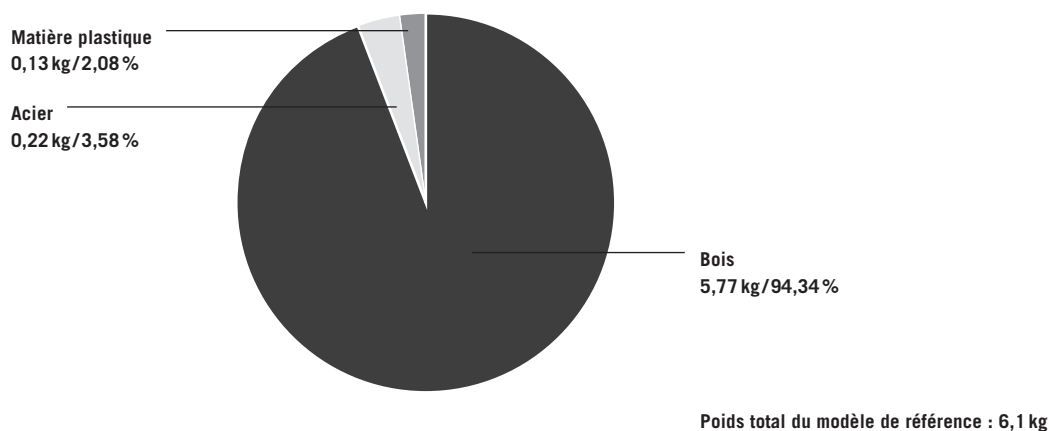

Informations environnementales : [www.bene.com/durabilite](http://www.bene.com/durabilite)

