



# SCHEDA TECNICA

## NX6417A5401

NEXIT 6417A

### SCHEDA TECNICA

**iMilani**  
innovative  
italian  
ideas

Dim. esterne	600x400x170h mm	
Dim. interne inf.	561x361 mm	
H utile interna	167 mm	
H utile impilate	152 mm	
H utile con coperchio	156 mm	
Passo di sovrapposizione	155 mm	
Volume	34,2 litri	
Peso	1,767 kg	
Temperatura d'impiego	+60 -20 °C	
Materiale	<b>ECOGREEN</b> 	
Colore	Grigio	
<b>SUPERFICIE DISP. PER MARCHIATURA</b>		
	<b>Dim.mm Max logo</b>	<b>H Lettere Mobili</b>
2 lati lunghi	L 220 h 40	15
2 lati corti	L 275 h 30	15

### ACCESSORI

Cassetta divisoria 1 ripartizione ECOGREEN	Art.	<b>AT64S15407</b>
Cassetta divisoria 2 ripartizioni ECOGREEN	Art.	<b>AT64S25407</b>
Cassetta divisoria 4 ripartizioni ECOGREEN	Art.	<b>AT64S45407</b>
Coperchio a due falde	Art.	<b>NX64CR5401</b>
Coperchio incernierato	Art.	<b>NX64HG5401</b>
Coperchio separato	Art.	<b>NX64SE5401</b>
Coperchio trasparente in polistirolo	Art.	<b>ATLID66896</b>
Coppia ganci di chiusura	Art.	<b>ATLOCK8113</b>
Divisorio a pettine 355 x 120 h mm passo fessure: 24mm	Art.	<b>D135512246801</b>
Divisorio a pettine 555 x 120 h mm passo fessure: 24mm	Art.	<b>D155512246801</b>
Porta etichette	Art.	<b>LHTYT</b>

<b>PORTATA (kg)</b>	<b>INFLESSIONE MAX DEL FONDO</b>
20	3% della diagonale del fondo
<b>PORTATA IN ACCATASTAMENTO (kg)</b>	<b>RIDUZIONE MAX DELLA PILA</b>
300	2 % dell'altezza iniziale
Determinato con peso uniformemente distribuito secondo EN13117-2:2000 a temperatura di 23 °C	

### NOTE GENERALI

Tolleranza sui pesi	± 3 %	
Tolleranza sulle quote	± 0,5 %	Non usare agenti chimici aggressivi.
Il potere calorifico del materiale, necessario per determinare il carico d'incendio del magazzino, è pari a 46 MJ / kg. Per questo articolo il valore è 81,28 MJ.		

Data ultimo aggiornamento: **13/09/2022**

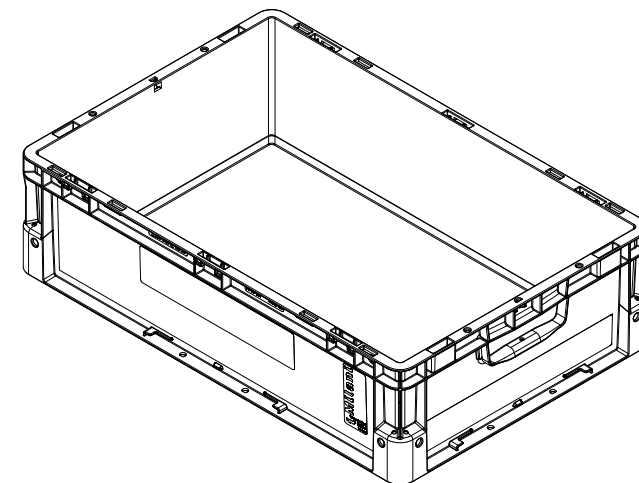
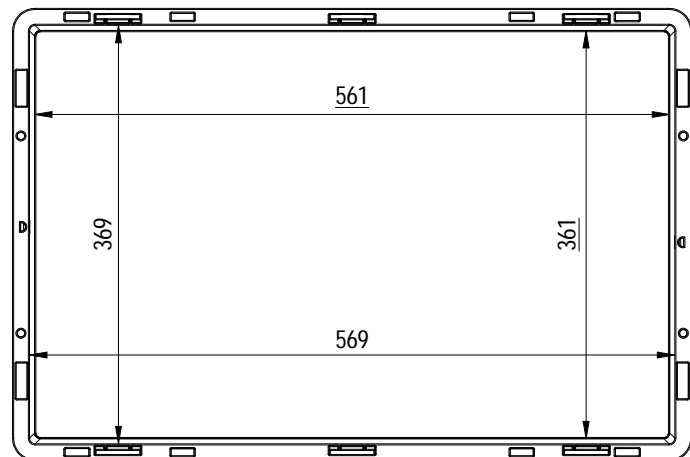
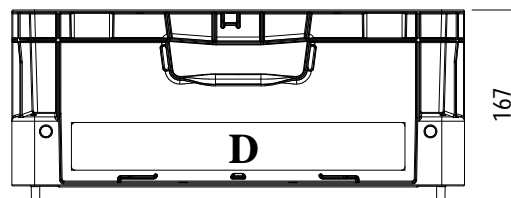
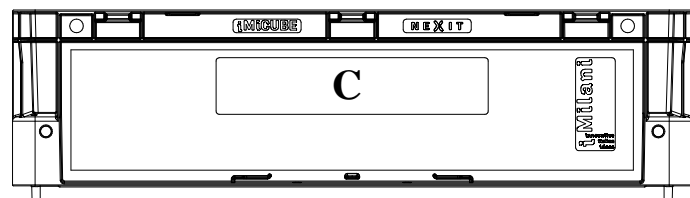
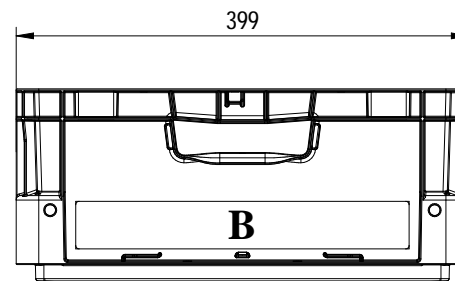
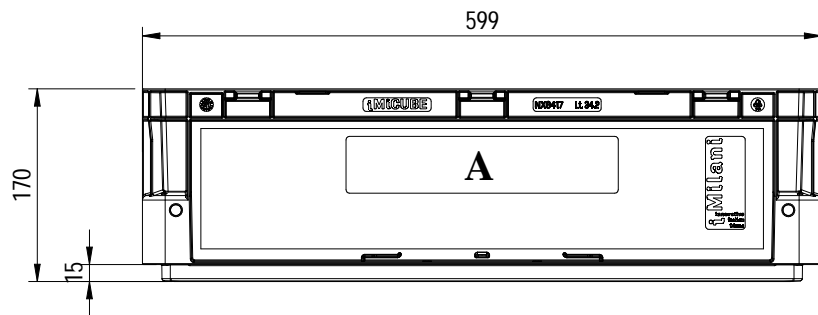

ARTICOLO PADRE:	<b>iMi256</b>		
COD. COMP.:	<b>NX6417A</b>	REV.:	
DIS. DA:	<i>Calzavara L.</i>		
DATA:	05/09/2022		
APPROV.:	<i>Grapiglia D.</i>		
DESCRIZIONE:		CASSETTA NEXIT IN PP - FONDO LISCIO	
MANIGLIE CHIUSE - DIM.		600X400X170H MM	
SCALA:	1:6,67	MATERIALE:	Polipropilene
PESO:		1,691 kg	
Riproduzione vietata a termine di legge NX6417A.dft			

Tolerance Group	Limit dimensions for nominal size range																
	1 to 3	3 to 6	6 to 10	10 to 18	18 to 30	30 to 50	50 to 80	80 to 120	120 to 180	180 to 250	250 to 315	315 to 400	400 to 500	500 to 630	630 to 800	800 to 1000	
TG6	NW	±0.12	±0.18	±0.22	±0.26	±0.31	±0.37	±0.57	±0.80	±0.93	±1.05	±1.15	±1.60	±2.20	±2.50	±2.80	±3.10

