

Les lampes

TABLE/DESK LAMPS

Lora

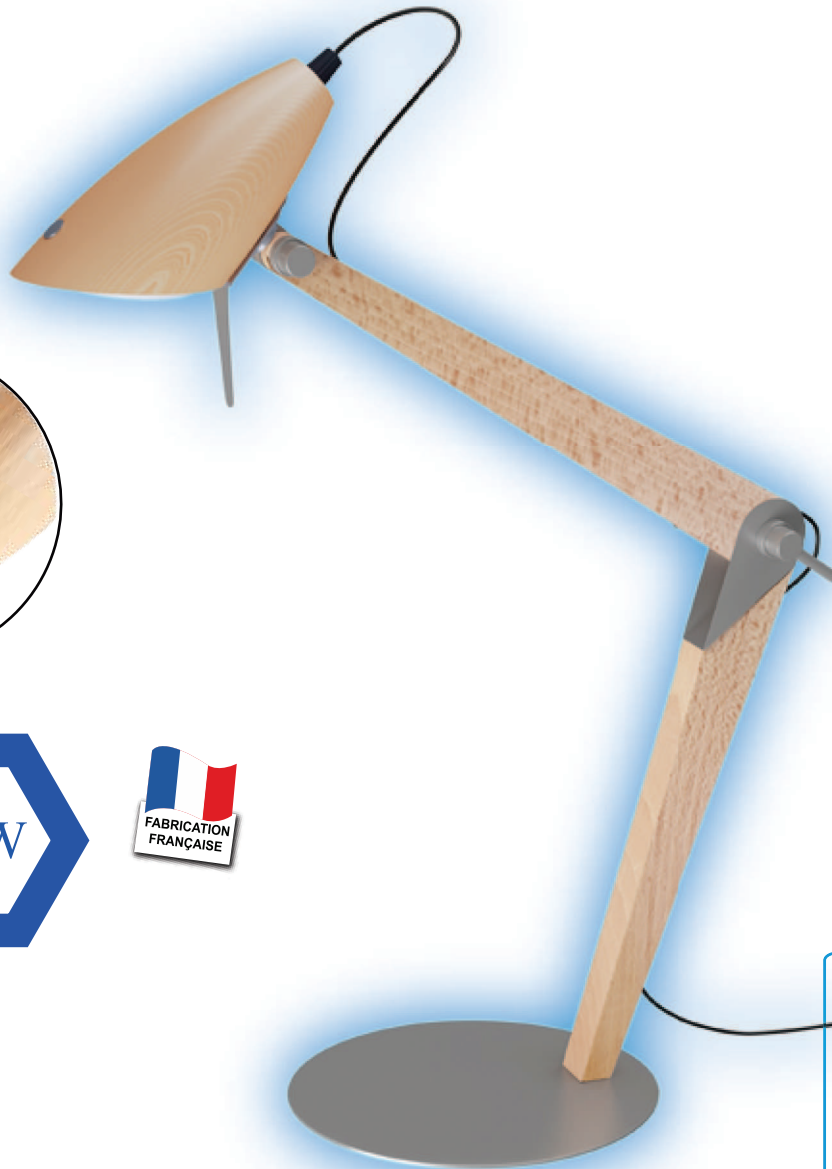

Interrupteur
switch

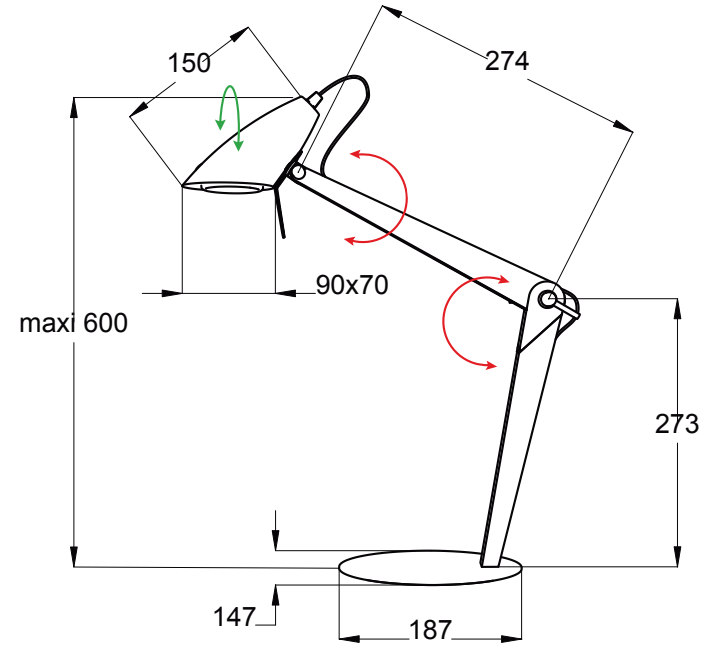
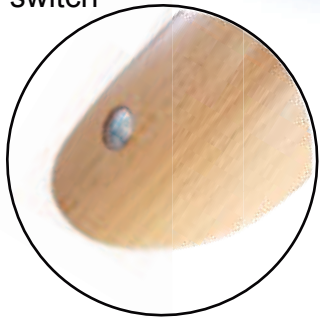

Document non contractuel

Energy efficiency scale (A++ to F) with 'LED' indicated. A red 'X' is drawn over the lower energy classes (C, D, E, F). Below the scale, it says: 'Les lampes de ce luminaire ne peuvent pas être changées.'

575 lumen	82 l/watt	4000 K°	80 CRI	30000 h	8 Kwh/1Kh
LED	7W				

ALUMINOR
LUMINAIRES

Quartier de la Roseyre - C.D.15 N°852 - 06390 Contes - France
Tél : 33 (0)4 93 91 60 10 - Fax : 33 (0)4 93 91 60 11
www.aluminor.fr - Email: contact@aluminor.fr





LAMPE DE TABLE
TABLE DESK LAMP
TISCH BÜROLEUCHTE
LAMPÁRA DE MESA
STAANDE LAMP
LAMPADA DA TAVOLO
CANDEIEIRO DE MESA



Acier
Steel
Stahl
Acero
Staal
Acciaio
Aço



LAMPADAIRE
UPLIGHT FLOOR LAMP
FLUTER STEHLEUCHTE
LAMPÁRA DE PIE
VLOERLAMP
LAMPADA DA TERRA
POSTE DE ILUMINAÇÃO



Aluminium
Aluminium
Aluminium
Aluminio
Aluminium
Alluminio
Alumínio



APPLIQUE
WALL BRACKET
WANDLEUCHTE
APLIQUE
WANDLAMP
LAMPADA DA PARETE
LAMPADA DE PAREDE



Matière synthétique
Plastic
Kunststoff
Plástico
Plastic
Plastica
Plástico



SUSPENSION
PENDANT
HÄNGELAMPE
SUSPENSIÓN
SCHERSING
LAMPADARIO A SOSPENSIONE
SUSPENSÃO



Bois
Wood
Holz
Madera
Hout
Legno
Madeira



DOUBLE ISOLATION
PROTECTION CLASS II
SCHUTZKLASSE II
CLASE DE PROTECCIÓN II
BESCHERMINGSKLASSE II
CLASSE DI PROTEZIONE II
CLASSE DE PROTEÇÃO II



Aj tissus
Fabric
Textil
Textil
Textiel
Textil
Textil



PRISE DE TERRE
PROTECTION CLASS I
SCHUTZKLASSE I
CLASE DE PROTECCIÓN I
BESCHERMINGSKLASSE I
CLASSE DI PROTEZIONE I
CLASSE DE PROTEÇÃO I



Verre
Glass
Glas
Vidrio
Glas
Vetro
Vidro



PROTECTION CLASS III
PROTECTION CLASS III
SCHUTZKLASSE III
CLASE DE PROTECCIÓN III
BESCHERMINGSKLASSE III
CLASSE DI PROTEZIONE III
CLASSE DE PROTEÇÃO III

CFL or LINEAR FLUORESCENT

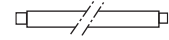

G5
from 24W to 54W
T5 according to product



E27 or E14 CFL
from 8W to 20W
according to product



2G7 CFL
from 9W to 11W
according to product

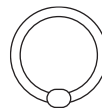

G10q or 2GX13 CFL
22W T5



2G11 CFL
55W according to product



E27 or E14 CFL standard
from 8W to 20W
according to product

HALOGEN LV & ELV



R7s 230/330W



G9 230 V
from 28W to 33W
according to product

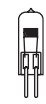

G4 or GY 6.35 12V 10 to 50W
according to product



E27 or E14 standard halo
from 18W to 42W
according to product

LED

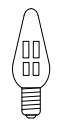

E27; E14; GU10; GY 6.35; G9
Utilisation possible de lampe LED " Retrofit"
" Retrofit" LED bulbs availables
mogelijke gebruik van LED lamp " Retrofit"

Glossaire / Glossary / Woordenlist Glossario / Glossário



Interrupteur à pied
Foot switch
Fußschalter
Interruptor de pie
Voetschakelaar
Interruttore piede
Interruptor pé



Interrupteur sensitif, 4 positions
Sensitive switch, 4 steps
Berührungsschalter, 4 Positionen
Interruptor sensitivo 4 posiciones
Sensor schakelaar 4 posities
Interruttore del sensore, 4 posizioni
Interruptor do sensor, 4 posições



Interrupteur sur fil
Lead switch
Schnurzwischenhalter
Interruptor intermedio de cordón
Kabelschakelaar
Interruptore su filo
Interruptor em fio



Interrupteur sur douille
Switch on socket
Fassungsschalter
Interruptor en casquillo
Socket schakelaar
Interruttore su portalampada
Interruptor na suporte da lâmpada



Interrupteur sur base
Switch on base
Schalter auf Lampenfuß
Interruptor en base
Schakelaar op de basis
Interruttore sulla base
Interruptor com base



Interrupteur 2 intensités sur base
Two way switch on base
Zweistufenschalter auf Fuß
Interruptor 2 intensidades en base
schakelaar 2 intensiteiten op de basis
Interruttore 2 intensità sulla base
Interruptor 2 intensidades com base



Variateur de lumière
Dimmer
Dimmer
Regulador de intensidad
Dimmer
Variatore di luminosità
Regulador para iluminação

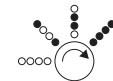

Interrupteur 4 positions
Four ways switch
Vierstufenschalter
Interruptor 4 posiciones
Schakelaar 4 posities
Interruttore 4 posizioni
Interruptor 4 posições

ALUMINOR

L U M I N A I R E S

ALUMINOR LUMINAIRE
Quartier de la Ros eyre - C.D. 15 N°852 - 06390 Contes - France
Tél. : 33 (0)4 93 91 60 10 - Fax : 33 (0)4 93 91 60 11
www.aluminor.fr - E-mail : contact@aluminor.fr